

Cross-Laminated Timber Structural Design

Basic design and engineering principles according to Eurocode

Cross-laminated timber as an innovative structural element opens up new possibilities in structural timber construction. The present guideline is to assist in properly exploiting and implementing these possibilities in planning and execution.

Firstly, the two-dimensional construction product cross-laminated timber (BSP or XLAM) is described with respect to its manufacture and its properties. This is followed by the description of the structural behaviour, basic design principles and fire performance and then modelling assumptions and characteristic material values according to Eurocode. Joining technology focuses on self-tapping woodscrews; this section is supplemented by general design proposals. Structural behaviour of buildings under horizontal loads and earthquake resistance associated therewith conclude the general part. Application examples underline the described contents for easier access and discussion of extensive engineering models.

DI Dr. Markus Wallner-Novak

DI Josef Koppelhuber

DI Kurt Pock

Cross-Laminated Timber Structural Design

Basic design and engineering principles
according to Eurocode

pro:Holz

Publication details

Owner and publisher

proHolz Austria

Working group of the Austrian
timber industry for promotion of
the application of timber

Chairman Hans Michael Offner
Managing Director Georg Binder
Project Management

Alexander Eder
1011 Vienna/Austria
Uraniastrasse 4
T + 43 (0)1/712 04 74
info@proholz.at, www.proholz.at

Financial support by

Binderholz Bausysteme GmbH
A-5400 Hallein
Solvay-Halvic-Straße 46
T + 43 (0)6245/70 500 - 556
office@binderholz-bausysteme.com
www.binderholz-bausysteme.com

Haas Fertigung Holzbauwerk
GesmbH & Co KG
A-8263 Großwilfersdorf
Radersdorf 62
T + 43 (0)3385/666 - 0
Info@Haas-Fertigung.at
www.haas-fertigung.at

Mayr-Melnhof Holz Holding AG
A-8700 Leoben, Turmgasse 67
T + 43 (0)3842/300 - 0
holding@mm-holz.com
www.mm-holz.com

Merk Timber GmbH
D-86551 Aichach
Industriestraße 2
T + 49 (0)8251/908 - 0
office@merk.de
www.merk.de

Hasslacher Norica Timber
A-9751 Sachsenburg
Feistritz 1
T + 43 (0)4769/2249 - 0
info@hasslacher.at
www.hasslacher.at

Stora Enso
Building and Living
A-9462 Bad St. Leonhard
Wisperndorf 4
T + 43 (0)4350/2301 - 3207
buildingsolutions@
storaenso.com
www.clt.info

Fachverband der Holz-
industrie Österreichs
A-1037 Wien
Schwarzenbergplatz 4
T + 43 (0)1/712 26 01
office@holzindustrie.at
www.holzindustrie.at

Authors
DI Dr. Markus Wallner-Novak
DI Josef Koppelhuber
DI Kurt Pock

Design

Cover Gassner Redolfi, Schlins (AT)
Reinhard Gassner, Marcel Bachmann
Contents Markus Wallner-Novak

Print Eberl Print, Immenstadt (DE)

Translation

Translation agency Allesprachen, Graz

1st edition english 2014, 600 copies
Translation on the basis of the German
version of September 2013
Price per copy 35 Euros, incl. VAT, excl. shipment
ISBN 978-3-902926-03-6
ISSN 1680-4252



PEFC
PEFC/04-31-0805

Printed on PEFC-certified paper. This product
originates from sustainably managed forests and
controlled sources. www.pefc.at

Copyright 2014 by proHolz Austria and the
authors. The publication and any contributions
and figures contained therein are copyrighted.
Any use beyond the limits of copyright without
the publisher's approval is inadmissible and
punishable. proHolz Austria and the authors
endeavour to research or state, respectively,
information correctly and completely. However,
we ask for your understanding that no liability
can be assumed for the contents.

Foreword

The development of timber construction over the past hundred years has been characterised by enormous innovation. The elements made of timber and timber materials as well as the joining technique have undergone constant further development. The timber, or more exactly the individual board, represents the basis for glued-laminated timber, board stack elements or cross-laminated timber. At the first glance, the relatively "new" construction material cross-laminated timber – its practical, economically relevant use in the building sector started about twenty years ago – is a simple construction material. It consists of strength-graded laminations, which are glued together crosswise at 90° to an odd number of layer. Superficially, a homogeneous wooden panel is formed. Upon closer examination by the engineer, however, the complexity of this structural element can be noticed: it is an orthogonally layered, laminar composite element made of wood with a complex calculation basis.

"Everything should be made as simple as possible, but not simpler."

(Albert Einstein, 1879–1955)

The present structural design manual is giving designers, engineering consultants and performers an understanding of the basic principles for technically proper planning and application of cross-laminated timber. The main focus is on the structural function of cross-laminated timber as a load-bearing structural element and on the requirements associated therewith. For joining the cross-laminated timber elements, design proposals were prepared. The structural design guideline enables practitioners an easy and fast understanding of the construction product cross-laminated timber, since the verifications required in terms of structural engineering are described with the associated engineering calculation models and explained on the basis of practical examples. This structural design manual was meticulously and thoroughly prepared by DI Dr. Markus Wallner-Novak and his co-authors DI Josef Koppelhuber and DI Kurt Pock. Here, the engineer will find answers to the essential issues when it comes to the structural design of cross-laminated timber, so that this manual represents an important contribution to practical dimensioning of cross-laminated timber.

Wilhelm Luggin

Luggin – Ziviltechnikergesellschaft m.b.H.

Contents

1	Definitions	5
1.1	Lowercase letters	5
1.2	Uppercase letters and abbreviations	5
2	Product description	8
2.1	General	8
2.2	Load-bearing effect	11
2.3	Joining technique	15
2.4	Further notes	15
2.5	Marking and designation of standard build-ups	16
3	Basic principles of calculation	19
3.1	Design concept	19
3.2	Characteristic building material values	22
3.3	Coefficients for impacts	26
3.4	Partial safety factors on the resistance side	27
3.5	Deformation coefficients	27
4	Cross-sectional values	29
4.1	Beams – Net cross-sectional values	29
4.2	Beams – Effective cross-sectional values	33
4.3	Biaxial load-bearing effect of panels	35
4.4	Plates	42
5	Ultimate limit states	45
5.1	Design situation	45
5.2	Tension in the element plane	46
5.3	Tension transverse to the element plane	47
5.4	Pressing of the front faces	48
5.5	Bending due to panel load	52
5.6	Bending upon stressing as an upright girder	53
5.7	Shear upon stressing as a panel	55
5.8	Shear upon stressing as a plate	57
5.9	Torsion upon stressing as a panel	59
5.10	Stability	60
5.11	Combined stress	65
5.12	Notches	68
6	Serviceability limit states	71
6.1	Design situation	71
6.2	Limitation of deflections	71
6.3	Vibrations	74
7	Ultimate limit states in the event of fire	87

7.1	Design situation	87
7.2	Charring and cross-sectional values.....	87
7.3	Verification.....	92
8	Loss of static equilibrium	93
8.1	Design situation	93
8.2	Lift-off	94
9	Joining techniques.....	97
9.1	Butt joints.....	97
9.2	Joint designs.....	99
9.3	Pin-type fasteners and their load-bearing capacity.....	105
9.4	Self-tapping woodscrews	105
10	Bracing of buildings.....	121
10.1	Impacts and design situations.....	121
10.2	Stability.....	127
10.3	Force progression	127
10.4	Diaphragms	129
10.5	Shear walls.....	131
11	Application examples.....	139
11.1	Basic principles.....	139
11.2	Ceilings	155
11.3	Roofs.....	165
11.4	Barrel-shaped roof.....	169
11.5	Walls	171
11.6	Shear walls.....	176
Annex	Calculation method.....	181
A.1	The extended Gamma method	181
A.2	The multilayer, shear-flexibly connected beam	184
A.3	List of references.....	188

1 Definitions

1.1 Lowercase letters

a	Distance from the centre of gravity of a layer to the overall centre of gravity; Minimum distance of the fasteners; Acceleration (earthquake)
b	Element width (in-plane element dimension normally transverse to the main direction of load-bearing capacity); Room width
c	Spring rigidity
d	Element thickness (dimension transverse to element plane) for fasteners: nominal diameter
d_i	Thickness of the individual layer i
f	Strength; Frequency
f_1	First natural frequency
g	Permanent loads
g_1	Dead weight of the load-bearing elements
g_2	Permanent superimposed loads
h	Element height (in-plane element dimension normally in the main direction of load-bearing capacity)
i	Radius of inertia
k	Factor
k_{led}	Load duration
l	In direction of load-bearing capacity upon statement of the panel build-up (longitudinal direction)
ℓ	System length, span, buckling length
m	Moment per running metre of panel; Mass per unit of area
n	Live load; Axial force per running metre of panel; Number
q	Linear load, live load; Coefficient of ductility (earthquake)
r	Smallest radius of curvature
s	Snow load
v	Lateral force per running metre of panel; Element of the flexibility matrix (extended Gamma method)
$vorh$	Existing value
w	Wind load/deflection transverse to the direction of load-bearing capacity upon statement of the panel build-up (width direction)
z	Ordinate of a layer in cross-section (Timoshenko-beam)
zul	Admissible

1.2 Uppercase letters and abbreviations

A	Area
B	Stiffness
$XLAM$	Cross-laminated timber

D	Lehr's damping factor (modal damping); Extensional stiffness of a plate; Compressive force (shear wall)
DL or L	Top layer longitudinal to the long element side
DQ or Q	Top layer transverse to the long element side
E	Modulus of elasticity, value of an impact
EI	Flexural stiffness
EQU	Limit states of loss of equilibrium (equilibrium)
F	Force
G	Shear modulus
H	Horizontal force
I	Moment of inertia
K	Stiffness (bending or axial force)
K	Longitudinal layer
M	Moment; Mass concentrated in one point
M^*	Modal mass
N	Axial force
NKL	Utilisation class
Q	Punctiform live load
R	Value of resistance for verification of load-bearing capacity
S	Static moment; Stiffness (shear)
SLS	Serviceability limit states
T	Shearing force in a joint; Duration of vibration (earthquake)
ULS	Ultimate limit states
V	Lateral force
W	Section modulus
Z	Tensile force (shear wall)

1.2.1 Greek letters

α_{FE}	Coefficient for the shear stiffness of plates
β	Coefficient of imperfection; Charring rate
γ	For earthquakes, coefficient of significance of the object
γ_i	For calculation of effective cross-sectional values: reduction factor for layer i according to the Gamma method
$\gamma_M, \gamma_G, \gamma_Q$	Partial safety factor
η	Factor
φ	Displacement
Ψ	Coefficient of combination
κ	Shear increase factor ($\geq 1,20$)
κ_z	Shear correction factor ($\leq 0,80$)
λ	Slenderness
μ	Coefficient of friction
ρ	Bulk density
σ	Normal stress
τ	Shearing stress

1.2.2 Indices

0In the direction of the top layer (main direction of span)
055 % fractile
90Transverse to the top layer (ancillary direction of span)
AStarting point (shear walls)
axAxial (fasteners)
brGross cross-sectional value of the uniformly considered cross-section
cPressure; Buckling coefficient
charCharring
crIndex for crack factor (crack)
creepCreeping
critTilting
dDesign value (afflicted with partial safety factors)
defCoefficient for determination of creep deformation
EEnd point (shear walls)
efEffective cross-sectional value considering cross-section build-up and shear flexibility (Gamma method)
fiConcerning fire dimensioning
finEnd value (of deformation)
g, GConcerning permanent impacts
horHorizontal
instStart value (of deformation)
kCharacteristic value (normally 5 % fractile without partial safety factors)
kiBuckling
MConcerning the material (partial safety factor); Bending
meanMean
minMinimum
modmodification for consideration of load duration and wood moisture
n, netNet cross-sectional value with consideration of the cross-section build-up, but without consideration of shear flexibility of the transverse layers
oTop
PPolar (moment of inertia)
QConcerning variable impacts
qsIn the quasi-permanent design situation
rmsRoot mean square
RRolling shear
refReference value
relRelative
sConcerning the centre of gravity
sysSystem coefficient
tTension
totTotal
TTorsion
uBottom
yPanel bending (about the y-axis)
zUpright bending (about the z-axis)

2 Product description

2.1 General

2.1.1 Definition

Cross-laminated timber is a two-dimensional, solid timber product for load-bearing applications. It consists of at least three board layers, which are glued together over their entire surface area at right angles to one another and generally result in a symmetrical cross-section. Up to three adjacent layers may be arranged with their fibres running in parallel, as long as their joint thickness does not exceed 90 mm.

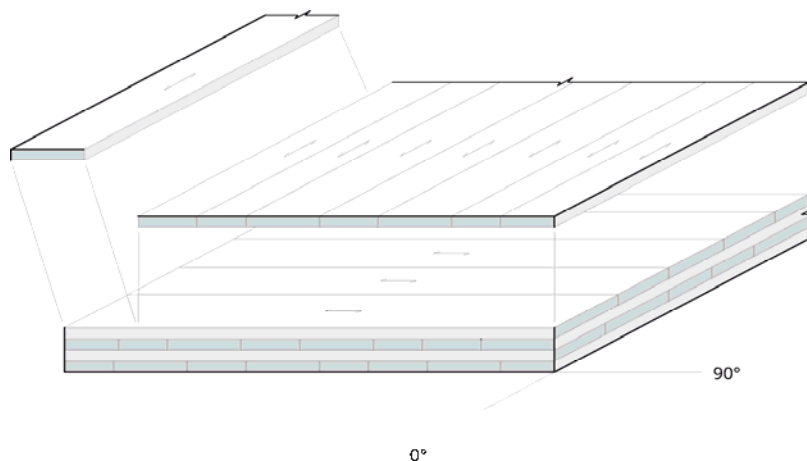

Figure 2-1: Cross-laminated timber build-up (exploded view)

The softwood boards of the individual layers are sorted by strength, planed, and kiln-dried. Predominantly, spruce wood of strength class C24 is used. Up to 10 % of the boards may have the next lower strength class. Common species of wood are also fir, pine, larch, and Douglas fir. Species of hardwood, like birch, are perceivable and currently being tested, but not yet covered by current approvals.

The boards are 40 to 300 mm wide and 6 to 45 mm thick, and they are normally connected into an infinite laminate in the longitudinal direction by means of finger joints, and, in a first production step, may be glued together at their narrow sides (flank-glued) to form a two-dimensional board layer. Without gluing of adjacent boards, these may be arranged with joints of no more than 6 mm. Relieving grooves in the boards may be up to 4 mm wide and 90 % of the board deep.

For curved cross-laminated timber, which is glued together in a suitable clamping device, the relation between the highest board thickness $d_{i,max}$ and the smallest bending radius r_{min} must be complied with¹:

$$r_{min} \approx 250 \cdot d_{i,max} \quad (2.1)$$

¹According to EN 16351:2013, the following applies exactly:

$d_{i,max} = \frac{r}{250} \cdot \left(1 + \frac{f_{m,jdc,k}}{80}\right)$ with the flexural strength $f_{m,jdc,k}$ of the finger-joint connection in the boards. In manufacturer-

specific approvals, the bending radius is limited depending on the board thickness.

The use of timber-based materials is admissible up to a portion in thickness of 50 %, if these are approved for utilisation class 2 and/or 3. With timber-based materials, certain properties, like load-bearing performance, acoustic behaviour, fire performance or appearance, can be influenced. The load-bearing capacity of these layers may be considered for the entire load-bearing effect, wherein joints of the timber-based materials must be observed.

In the present guideline, the individual parts of cross-laminated timber elements are designated according to Figure 2-2. In the literature, the term lateral face is also used for *surface* and the term narrow side is also used for *front face*.

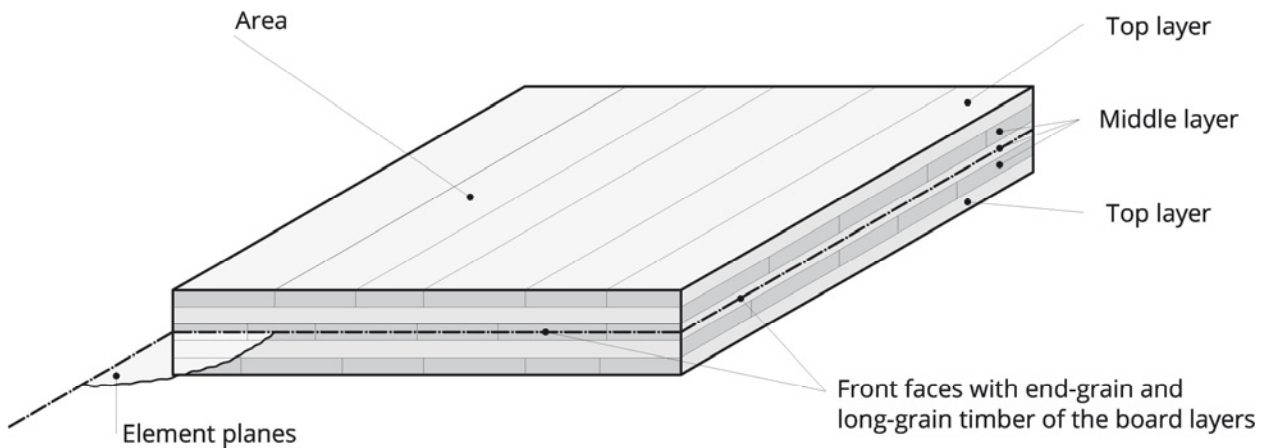

Figure 2-2: Designation of parts and areas of cross-laminated timber

2.1.2 Dimensions

Cross-laminated timber is manufactured in lengths of up to 16 m and widths of up to 2,95 or 3,00 m, respectively, and overall thicknesses for standard build-ups of up to about 300 mm, and at special request up to 500 mm, as shown in Figure 2-3. According to certain approvals, these maximum dimensions are currently extended up to 30 m by 4,80 m.

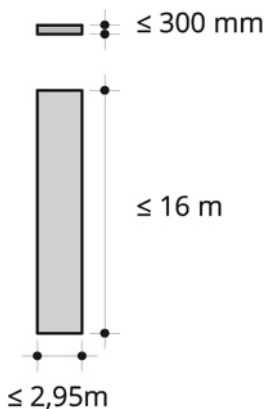

Figure 2-3: Dimensions of cross-laminated timber

2.1.3 Approval as construction product

Cross-laminated timber has been produced since 1995, however, has not been included into standards so far. Therefore, its use under building law is regulated through national or European Technical Approvals (ETA). The approvals include minimum requirements to the product, its initial materials and its manufacture, details for verification procedures and, in case of the ETA regulations, for CE marking.

The product standard EN 16351:2013 was submitted to the CEN members for voting and will result in an EN standard. A group of experts within the Standards Committee CEN TC 250 is currently working on the inclusion of cross-laminated timber into Eurocode 5 (EN 1995-1-1).

2.1.4 Use

Figure 2-4 gives an overview over the most important possible uses of cross-laminated timber as a structural element.

Cross-laminated timber has been approved for utilisation classes 1 and 2. Utilisation class 2 corresponds to an ambient climate of 20 °C, in which an air humidity of 85 % is exceeded for only a few weeks each year. This normally corresponds to roofed-over structural components protected from the elements. For this ambient climate, an equilibrium moisture content of the timber of no more than 20 % results for softwood.

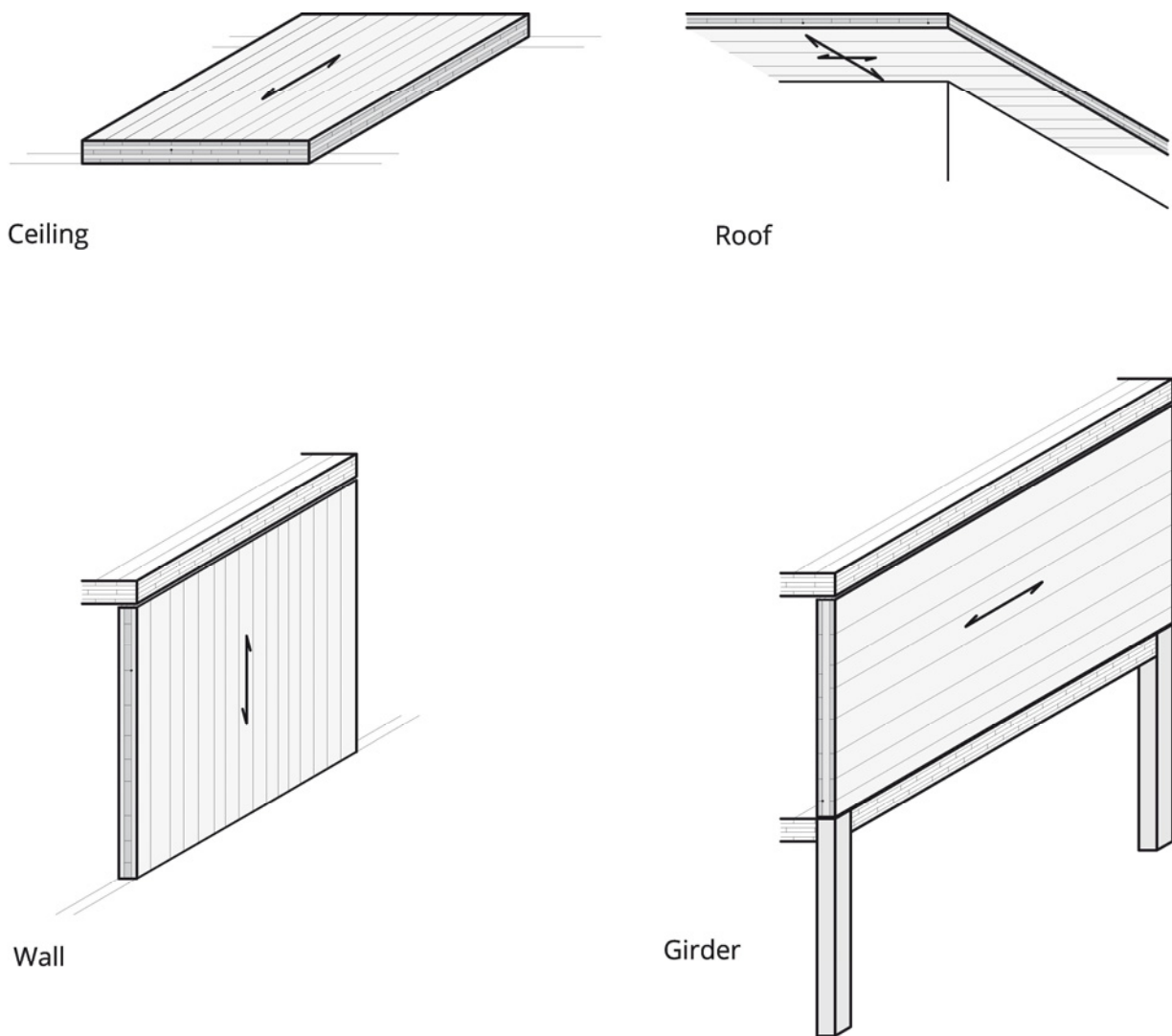

Figure 2-4: Use of cross-laminated timber in the structure

2.1.5 Gluing

For gluing of the board layers, the two adhesive systems polyurethane (PUR) and melamine-urethane-formaldehyde (MUF) are currently used. As a further adhesive system, solvent-free dispersion adhesives (EPI) may be used. The adhesives described have relatively short curing times and result in transparent joints. Different adhesives may result in a different fire performance.

2.2 Load-bearing effect

The interlocked build-up of cross-laminated timber results in an improved swelling and shrinking behaviour. Horizontally, the elements as panels are predominantly stressed in one direction (uniaxially) (Figure 2-5). In some cases – as with point-supported panels or with bilateral roof overhang – load distribution takes place in two directions.

Used as a vertical plate, the comparatively high shear stiffness and, due to the interlocked layers, also an improved shear capacity can be used.

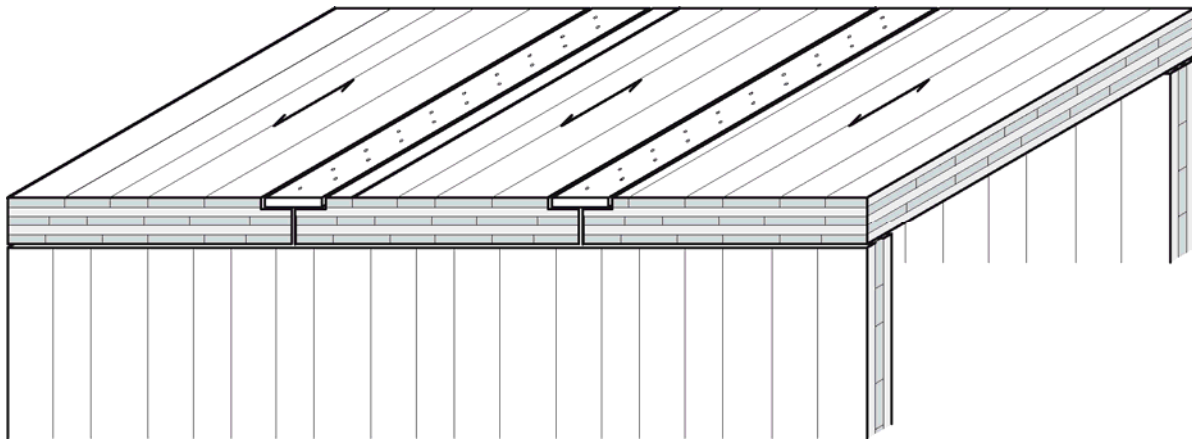

Figure 2-5: Cross-laminated timber – uniaxial load distribution

The main direction of load-bearing capacity (0°) is the one with higher stiffness, and the ancillary direction of load-bearing capacity (90°) is the one with lower stiffness. The main direction of load-bearing capacity normally corresponds to the direction of the top layers.

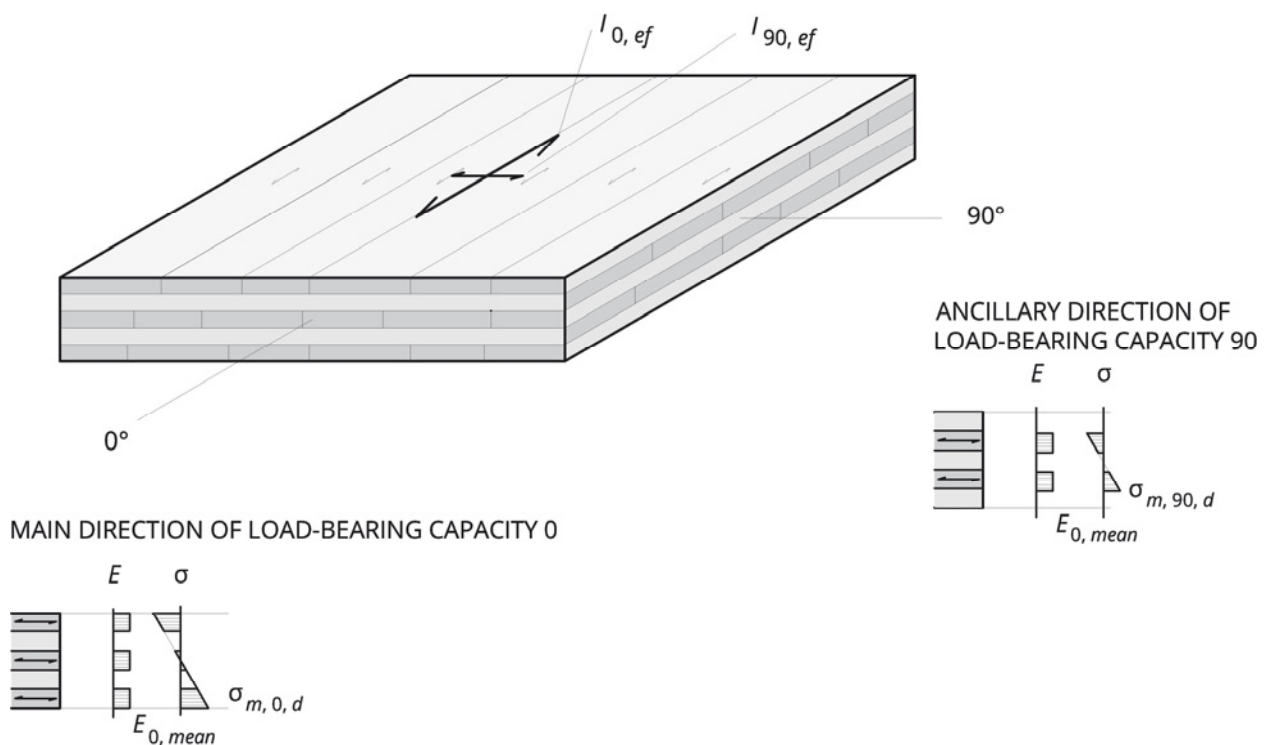

Figure 2-6: Cross-laminated timber element with main and ancillary direction of load-bearing capacity

For determination of the load-bearing performance upon panel bending in one direction, only those board layers are included in the calculation, which run in this direction of load-bearing capacity. The cross-sectional values belonging to this **net cross-section** are provided with the index “n” and used for verifications in the ultimate limit states. The transverse board layers are not assigned longitudinal stresses – here, the modulus of elasticity transverse to the fibre is assumed with $E_{90} = 0$.

Thus, the transverse layers are considered as pure spacers and are only subject to shear. This shear stress of the transverse layers must be observed with respect to load-bearing capacity and deformation of the cross-laminated timber. If shear failure occurs, then normally a break tangential to the annual ring areas of the transverse layers can be observed. This break is called *rolling shear failure*

and it is induced by exceeding the *rolling shear strength* $f_{V,R,k}$. It only amounts to about half to one third of the shear strength in the direction with the fibres running in parallel $f_{V,k}$.

The shear deformation of the transverse layers must be considered as part of the overall deformation.

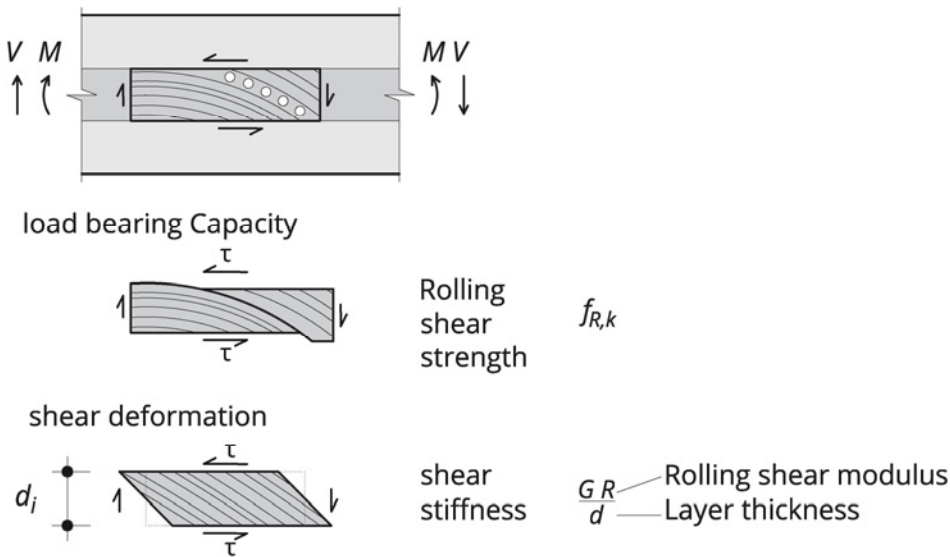

Figure 2-7: Shear behaviour of the transverse layers

For the load-bearing performance described, different calculation models may be applied. A simple model is that of the dowelled beam. The longitudinal layers are considered as parts of the beam's cross-section and the transverse layers as laminar doweling of the cross-section parts, as shown in Figure 2-8.

Cross-laminated timber as beam

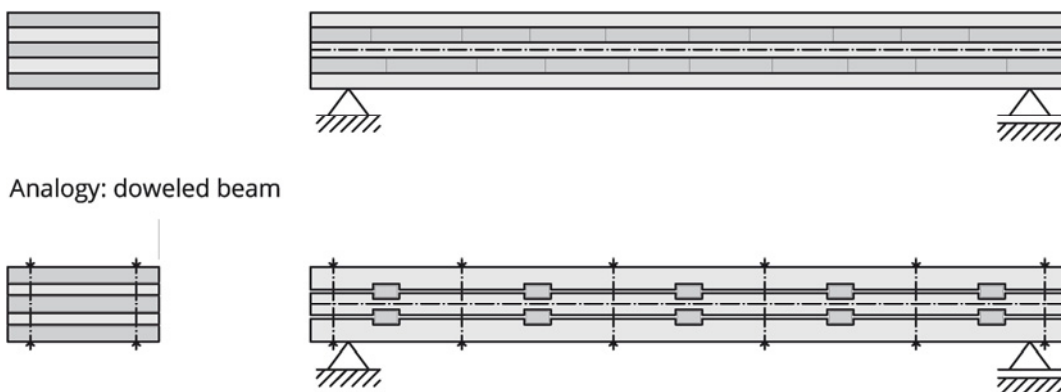

Figure 2-8: Model comparison with dowelled beam

The overall deformation consists of a bending portion as a consequence of torsion of the cross-section and a shear portion as a consequence of deformation of the transverse layers. The portion of shear deformations depends on the cross-section build-up, the element's slenderness and the load pattern and typically lies below 30 % of the bending deformations, as shown schematically in Figure 2-9.

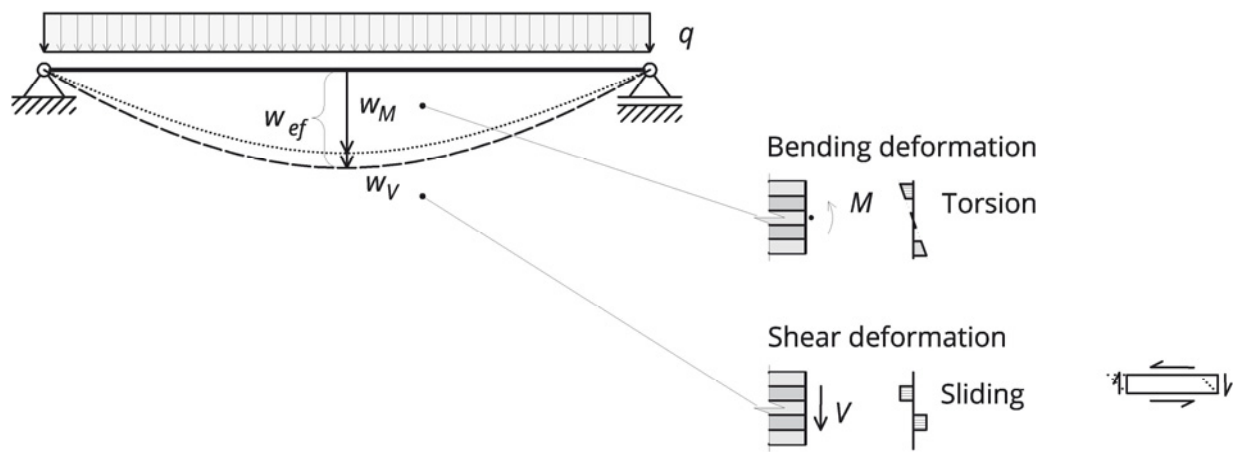

Figure 2-9: Deformation portions of a cross-laminated timber beam from bending and shear

For calculation of flexibly connected flexural members, the Gamma method has been described and included into the general design standards. Beside the Gamma method, the Timoshenko beam, the shear analogy method, the laminate theory and the calculation according to the finite element method are suited as well.

The Gamma method forms the basis for the deformation calculation in the present guideline. It is anchored in Eurocode 5 and most of the approvals for cross-laminated timber, has proven itself in building practice and represents a simple and engineering-based approach to the comprehension of shear deformations. The longitudinal layers are respectively reduced by a factor γ , in order to allow for the shear flexibility of the adjacent transverse layers. The associated *effective moment of inertia* is designated with the index "ef" and used for the verifications in the serviceability limit states. Consequently, the shear flexibility is considered via a reduced, effective flexural stiffness.

One advantage of the Gamma method is the fact that deformations can be calculated, as usual, through pure bending deformation. In manual calculation, no separate terms for shear deformations must be determined, and framework programmes don't have to consider the shear flexibility of members. Disadvantageous is the fact that the effective moment of inertia I_{ef} depends on the span l and thus is a system-dependent value. With shorter spans, the effective moment of inertia decreases more or less quadratically to the bending slenderness (l/h). The formulae for the Gamma values were obtained from the approach of a sinusoidal bending line.

Calculation of the cross-sectional values according to the Gamma method is described in Section 4.2. Upon application of the Gamma method in framework programmes, it proves practical to define cross-laminated timber as a uniform cross-section with the actual element height and effective width, as shown in Figure 2-10. The substitute cross-section then has the same height and flexural stiffness as the cross-laminated timber element; determination of stresses from the internal forces calculated this way, however, must be undertaken separately.

$$b_{ef} = b \cdot \frac{I_{ef}}{I_{br}} \quad (2.2)$$

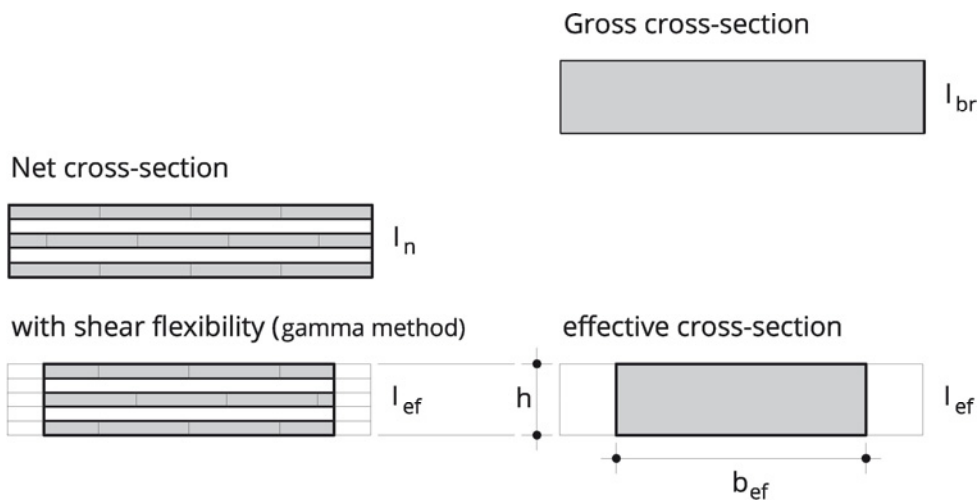

Figure 2-10: Model cross-sections and stiffness ratios

As an alternative calculation method, the shear-flexible *Timoshenko beam* is described in Annex A.2. Using this method, a shear correction factor may be stated for each cross-section build-up. Shear deformations may then be determined from lateral force distribution in addition to bending deformation.

2.3 Joining technique

Due to the interlocked build-up, cross-laminated timber is well suited for contact joining, since the loads can be applied via end pressing of the layers oriented in the direction of force. Pin-shaped fasteners can be arranged in the surface as well as in the front faces and axially stressed and/or subjected to shear. Upon use in the surface, the interlocked build-up of cross-laminated timber has a favourable effect on the transmissible forces and the minimum distances of the fasteners. The minimum distances may be determined independent of the orientation of the top layers.

Load application problems are discussed in more detail in Section 9.1, pin-shaped fasteners in Section 9.3.

2.4 Further notes

In Ebner (2003), building structures are described; building physics key figures can be found, among others, in HFA (2003). Teibinger und Matzinger (2013) wrote an article on building with cross-laminated timber in multi-storey construction. Green (2012) wrote a feasibility study on high-rise buildings.

2.5 Marking and designation of standard build-ups

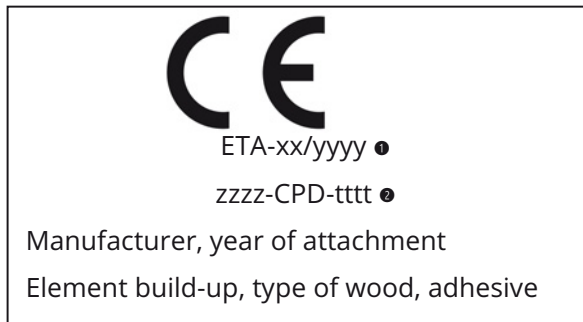

- Approval number
- Number of the certificate of conformity

Figure 2-11: CE marking according to European Technical Approval (ETA)

Fulfilment of a European Technical Approval or the product standard is documented via the CE mark at the product and in the accompanying documents, as shown by way of example in Figure 2-11.

For designation of cross-laminated timber elements, normally the manufacturer's product designation, the element thickness and the element build-up are used, as shown in Figure 2-12 and used in the present guideline.

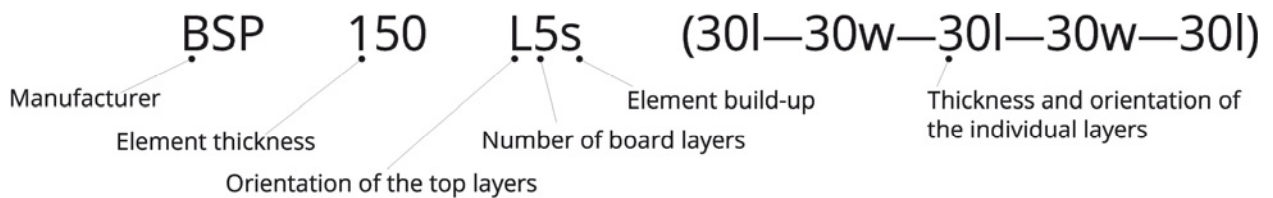

Figure 2-12: Designation scheme for the build-up of cross-laminated timber elements

As shown in Figure 2-13, in the present guideline, elements with a top layer longitudinal to the long element side are designated with *L*; common is also the designation *DL*. Elements with this orientation are normally used as roof and ceiling elements or upright as girders. Elements with a top layer transverse to the long element side are designated with *Q* (also *DQ*) and are used, for example, as wall elements.

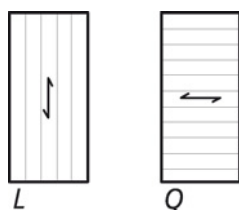

Figure 2-13: Orientation of the top layers conditional on manufacturing

For a manufacturer-neutral formulation in tender documents, the thicknesses of the individual board layers should be stated – in addition to the overall thickness. For that, in the product standard¹, the designation was determined with the respective layer thickness and the letters “l” for longitudinal layers (longitudinal direction) and “w” for transverse layers (width direction).

Figure 2-14 shows examples for element build-ups with their designation.



CLT110 L3s



CLT150 L5s

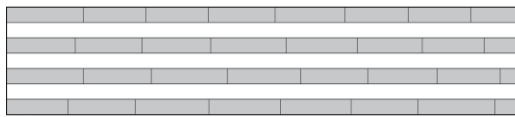

CLT210 L7s

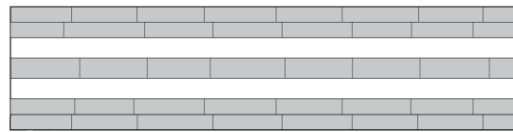

CLT240 L7s-2

Figure 2-14: Cross-section variants

¹ EN 16351:2013.

3 Basic principles of calculation

As the basis for structural design, the European safety concept is represented here with its basic principles and in a condensed form. As an estimate, secured data are given in order to enable checks and manual approximate dimensioning.

3.1 Design concept

The Eurocodes are issued with uniform contents across Europe. National annexes (NAD) serve making country-specific determinations for specific paragraphs, characteristic values and factors and respective amending of the contents. For dimensioning and design of timber structures, the European standard ÖNORM EN 1995-1-1, and additionally the national annex (for Austria, for example, ÖNORM B 1995-1-1) must be applied. For clear reference to a particular issue of a standard document, its year of issue is added – for example ÖNORM EN 1995-1-1:2008.

The objective of any structural design is the verification against the occurrence of undesired limit states. These are loss of static equilibrium (e.g. lift-off), exceeding of the load-bearing capacity or serviceability. Safety factors for impacts as well as resistances are determined against the occurrence of these limit states.

3.1.1 Characteristic values of impacts

Cross-laminated timber has been generally approved for static and quasi-static impacts. All impacts, as, for example, dead loads, live loads, snow loads or wind loads, are stated as characteristic values in the respective parts of Eurocode 1. Characteristic values of impact are obtained from measurements and load models and, within a reference period (normally 50 years), are exceeded in only 5 % of all cases (95 % fractiles).

Characteristic value of impact: E_k

3.1.2 Design values of stress

In the verifications, the stress on the structural elements has to be analysed, wherein effects and impacts are observed. Each limit state is allocated a design situation with associated combination rules. The characteristic values of impacts are provided with partial safety factors and combination coefficients and added up for unfavourable conditions.

The partial safety factors are γ_G for permanent impacts and γ_Q for variable impacts. The coefficients ψ to be applied for the various limit states are listed in Table 3-1. Using them, variable impacts may be reduced, for example, if they act in an accompanying fashion together with a leading variable impact. The coefficients depend on the respective load type, are determined in EN 1990 and stated here in Section 3.3.

The combined sums of impacts, afflicted with safety factors, in predetermined design situations result in the

Design value of impact: E_d

Table 3-1 Design situations and combination coefficients

Coefficients Limit states	ψ_0	ψ_1	ψ_2
Loss of static equilibrium (EQU), Load-bearing capacity (ULS)	Rare or temporary design situation	Extraordinary design situation	
	Verification of the load-bearing capacity	Verification of the load-bearing capacity in the event of fire or earthquake	
Serviceability (SLS)	Characteristic design situation	Frequent design situation	Quasi-permanent design situation
	Avoidance of damage	-	Appearance

3.1.3 Characteristic values of strength

The resistance of cross-laminated timber elements depends on their build-up and the material strength. The characteristic values of strength f_k are obtained from standardised materials testing or derived from known relations between various material strengths, and normally are those values, which are undercut by 5 % of the samples only.

Characteristic value of strength: R_k

3.1.4 Design values of resistance

On the materials side, the partial safety factor γ_M is used. In addition, for timber strengths, the influence of load duration and timber moisture is considered with the modification coefficient k_{mod} .

Design value of resistance: R_d

3.1.5 Verification

The demanded structural safety is achieved, when it can be demonstrated within the scope of verifications, that the respective design value of stress is smaller than or equal to the respective design value of resistance.

Verification: $E_d \leq R_d$

The exemplary quantity value of an impact is shown in the bar chart in Figure 3-1 on the left, and the resistance value on the right. The characteristic values are respectively shown on the outside, and the design values used for verification on the inside.

In the German-speaking area, the safety factor from characteristic value to design value for impacts as well as for resistances lies below the value of 1,50. The entire safety distance between the characteristic values lies at about 2,25 to 2,50. This corresponds to the safety level of the old deterministic safety concept, as shown in the second chart on the right. This comparison of the safety concepts with coarse standard values and simplifications serves understanding and limitation and is not intended for general static verifications.

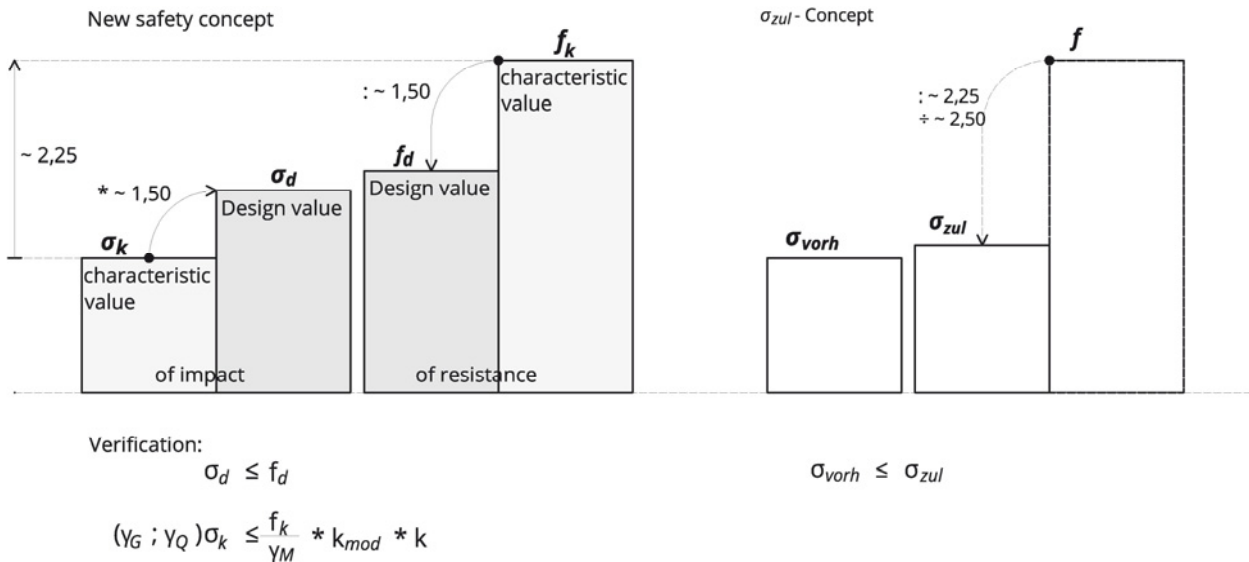

Figure 3-1: Characteristic values and design values with rounded partial safety factors

3.1.6 Design value of impact (load-bearing capacity)

$$E_d = \sum \gamma_G \cdot E_{G,i,k} + \gamma_Q \cdot E_{Q,1,k} + \sum \psi_0 \cdot \gamma_Q \cdot E_{Q,i,k} \quad (3.1)$$

Estimate:

$$E_d \approx 1,5 \cdot E_k$$

3.1.7 Design value of resistance (load-bearing capacity)

$$R_d = k_{mod} \cdot \frac{R_k}{\gamma_m} \quad (3.2)$$

Estimate:

$$R_d \approx \frac{R_k}{1,5}$$

In the present guideline, the resistances for cross-laminated timber are stated as design values ($\gamma_m = 1,25$) at a medium load duration ($k_{mod} = 0,8$ in utilisation classes 1 and 2). For deviating load durations, the factors according to Table 3-7 on page 24 must be applied. Deviating national determinations must be observed.

3.2 Characteristic building material values

Cross-laminated timber has been accepted as a construction product on the basis of technical approvals and is not standardised. The characteristic building material values from the technical approvals lie within certain ranges of variation, as stated in the following tables. In the present guideline, secured values were determined and are shown underlined. For static verification of a building, the exact values from the respective approvals are decisive.

3.2.1 General characteristic building material values

Table 3-2 General characteristic building material values

		Suggested design values	Value range according to approvals
Density (for load assumptions)	γ	5,50 kN/m ³	(4,20 ¹ ÷ <u>5,50</u>) ÷ 6,00 ² kN/m ³
Characteristic minimum value of bulk density	ρ_k	400 kg/m ³	350 ³ ÷ <u>400</u> ⁴ kg/m ³
Mean bulk density	ρ_{mean}	450 kg/m ³	450 kg/m ³

3.2.2 Characteristic building material values for panels

Table 3-3 Coefficients of stiffness for cross-laminated timber upon use as a panel

		Suggested design values	Value range according to approvals
Modulus of elasticity (normal stresses)	$E_{0,mean}$	11.000 N/mm ²	<u>11.000</u> ÷ 12.000 N/mm ²
	$E_{0,05}$	9.160 N/mm ²	7.330 ÷ <u>9.160</u> ÷ 9.650 N/mm ²
Modulus of elasticity (transverse to fibre)	$E_{90,mean}$	370 N/mm ²	<u>370</u> N/mm ²
Shear modulus	$G_{0,mean}$	690 N/mm ²	600 ÷ <u>690</u> ÷ 720 N/mm ²
	$G_{0,05}$	570 N/mm ²	
Rolling shear modulus	$G_{R,mean}$	50 N/mm ²	<u>50</u> ÷ 60 N/mm ²

¹ ρ_{mean} in EN 338:2009.

² ÖNORM B 4010.

³ EN 338:2009. The bulk density is normally stated for solid wood without consideration of the homogenisation effects of cross-laminated timber.

⁴ Blaß und Uibel (2007)

Table 3-4 Coefficients of strength for cross-laminated timber upon use as a panel

		Suggested design values f_d for $k_{mod} = 0,80$ and $\gamma_m = 1,25$	Range for characteristic values according to approvals
Flexural strength ¹	$f_{m,d}$	15,30 N/mm ²	24,00 N/mm ²
Tensile strength	$f_{t,0,d}$	9,00 N/mm ²	14,00 ÷ 16,50 N/mm ²
Compressive strength in direction of fibre	$f_{c,0,d}$	13,40 N/mm ²	21,00 ÷ 24,00 N/mm ²
Lateral compressive strength ²	$f_{c,90,d}$	1,60 N/mm ²	2,50 ÷ 2,70 N/mm ²
Shear strength	$f_{v,d}$	1,60 N/mm ²	2,00 ÷ 2,50 ÷ 2,70 N/mm ²
Rolling shear strength ³	$f_{v,R,d}$	0,70 N/mm ²	0,70 ÷ 1,10 ÷ 1,50 N/mm ²
Torsional strength	$f_{0,T,d}$	1,60 N/mm ²	2,50 N/mm ²

For deviating values of k_{mod} , see Table 3-7. For deviating values of γ_m , see Table 3-9.

3.2.3 Characteristic building material values for upright plates and girders

The following characteristic material values apply to upright plates and girders made of cross-laminated timber, in which the layers under stress consist of continuously finger-jointed board layers, as is normally demanded in the product approvals.

Table 3-5 Coefficients of stiffness for cross-laminated timber upon use as a plate

		Suggested design values	Value range according to approvals
Modulus of elasticity (normal stresses)	$E_{0,mean}$	11.000 N/mm ²	11.000 ÷ 12.000 N/mm ²
	$E_{0,05}$	9.160 N/mm ²	7.330 ÷ 9.160 ÷ 9.650 N/mm ²
Shear modulus	$G_{0,mean}$	690 N/mm ²	600 ÷ 690 ÷ 720 N/mm ²
	$G_{0,05}$	570 N/mm ²	

¹ For universally finger-jointed cross-laminated timber elements, the flexural strength for stress upon use as a panel stress must be reduced by 25 %.

² The characteristic compressive strength transverse to the fibre is stated in EN 16351:2013, Section 5.1.5 with $f_{c,90,k} = 3$ N/mm² for all types of wood, if no test results are present.

³ Attention! Shape and processing of the board layers decisively influence the rolling shear strength. Therefore, here, in particular, reference is made to the product approval.

If the boards are edge-glued or if, with missing edge gluing, a minimum width to thickness ratio of 4:1 is complied with, then, according to EN 16351:2013, Section 5.1.5, a characteristic rolling shear strength of 1,10 N/mm² may be applied, otherwise 0,70 N/mm².

Table 3-6 Coefficients of strength for cross-laminated timber upon use as a plate

		Suggested design values f_d for $k_{mod} = 0,80$ and $\gamma_m = 1,25$	Range for characteristic values according to approvals
Flexural strength	$f_{m,d}$	15,3 N/mm ²	24,00 N/mm ²
Tensile strength¹	$f_{t,0,d}$	9,0 N/mm ²	14,00 ÷ 16,50 N/mm ²
Compressive strength in direction of fibre	$f_{c,0,d}$	13,4 N/mm ²	21,00 ÷ 24,00 N/mm ²
Lateral compressive strength	$f_{c,90,d}$	1,6 N/mm ²	2,50 ÷ 2,70 N/mm ²
Shear strength of the plate (Mechanism 1)	$f_{V,S,d}$	3,2 N/mm ²	5,00 N/mm ²
Torsional strength of the glued joints (Mechanism 2)	$f_{V,T,d}$	1,6 N/mm ²	2,50 N/mm ²
Shear strength (Mechanism 3)	$f_{V,d}$	1,6 N/mm ²	2,00 ÷ 2,50 ÷ 2,70 N/mm ²
Rolling shear strength²	$f_{V,R,d}$	0,7 N/mm ²	0,70 ÷ 1,10 ÷ 1,50 N/mm ²

For deviating values of k_{mod} , see Table 3-7. For deviating values of γ_m , see Table 3-9.

3.2.4 Conversion by load duration

Table 3-7 Factors for design values by load duration in utilisation classes 1 and 2

Load duration	KLED	permanent	long	medium	brief	very brief
	k_{mod}	0,60	0,70	0,80	0,90	1,10
	Load abbreviation	G	NE	NA, NB, ND,NF,NG S1	NC, NH S2 W	(W)
Factor	$\eta_{k_{mod}}$	0,75	0,88	1,00	1,13	1,38

3.2.5 System coefficient

By gluing, several boards of one layer are linked up in parallel. Load distribution takes place via several structural elements simultaneously, which is why the element resistance may be increased with

¹ For universally finger-jointed cross-laminated timber elements, the flexural and tensile strengths for stress upon use as a plate must be reduced by 30 %.

² Attention! Shape and processing of the board layers decisively influence the rolling shear strength. Therefore, here, in particular, reference is made to the product approval.

If the boards are edge-glued or if, with missing edge gluing, a minimum width to thickness ratio of 4:1 is complied with, then, according to EN 16351:2013, Section 5.1.5., a characteristic rolling shear strength of 1,10 N/mm² may be applied, otherwise a rolling shear strength of 0,70 N/mm².

the system coefficient k_{sys} due to static effects compared to the board strength.¹ With application of a high average board width of 25 cm, for elements with a width from 100 cm, $k_{sys} = 1,08$ results, and from 200 cm, $k_{sys} = 1,20$. The increase in strengths with k_{sys} only applies with parallel stressing of several boards, like with normal and bending stresses, however, not if only one board is subject to rolling shear.

For narrow elements with a width of less than 25 cm, a reduction by $k_{sys} = 0,90$ is recommended.

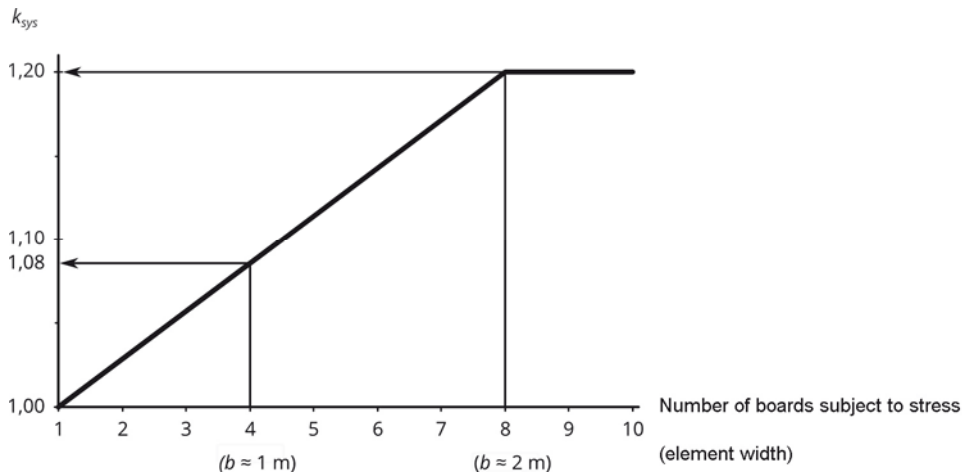

Figure 3-2: Relation between number of boards subject to stress and k_{sys}

¹ EN 1995-1-1, Section 6.6.

3.3 Coefficients for impacts

In Table 3-8, all coefficients required for structural design are stated for various load categories. The partial safety factors γ apply to the ultimate limit states. The modification coefficients for load duration k_{mod} , which in the verification equation are on the materials side, correspond to the values for plywood according to EN 1995-1-1:2009. The combination coefficients are taken from Tables A.1.1. and A.1.2. of EN 1990:2003. The respective class of the load duration KLED was taken over from DIN 1052:2004, Table 4.

Table 3-8 Load categories and associated coefficients

Group	Category	Load abbreviation	γ_{sup}	γ_{inf}	KLED	k_{mod} NKL 1, 2	ψ_0	ψ_1	ψ_2
Permanent loads		G	1,35	1,00	permanent	0,60	-		
Live loads in building construction	A: Living areas	NA	1,50	0,00	medium	0,80	0,70	0,50	0,30
	B: Office areas	NB			medium				
	C: Accumulations of people	NC			brief	0,90		0,70	0,60
	D: Sales areas	ND			medium	0,80	1,00	0,90	0,80
	E: Storage and industrial utilisation	NE			long	0,70			
	F: Traffic and parking areas (light)	NF			medium	0,80			
	G: Traffic and parking areas (medium)	NG			medium		0,50	0,30	
	H: Roofs	NH			brief	0,90	0,00	0,00	0,00
	Balconies, accesses, etc.	N1			brief		0,70	0,50	0,30
Snow loads in building construction	Locations above 1.000 m above sea level	S1	1,50	0,00	medium	0,80	0,70	0,50	0,20
	Locations below 1.000 m above sea level	S2			brief	0,90	0,50	0,20	0,00
Wind loads in building construction		W	1,50	0,00	brief	0,90	0,60	0,20 ¹	0,00

¹ Except for this value, the table in DIN 1055-100:2001 is identical. There, $\psi_1 = 0,50$.

3.4 Partial safety factors on the resistance side

The partial safety factors on the resistance side may be determined nationally and must be observed in any case. Table 3-9 states the partial safety factors for some countries in an exemplary fashion.

Table 3-9 Partial safety factors

Building material or structural element, resp.	γ_m
Solid wood	
EN 1995	1,30
AT, DE, GB	1,30
IT	1,50
Glued-laminated timber	
EN 1995	1,25
AT, GB, FR, ES	1,25
DE	1,30
IT	1,45
Cross-laminated timber	
EN 1995	-
AT, GB	1,25
DE, FR, ES	1,30
IT	1,50
Connections	1,30

3.5 Deformation coefficients

The creep deformation depends on the utilisation class and can be determined with k_{def} according to Table 3-10 by multiplication of the initial deformation in the quasi-permanent design situation

$$W_{inst,qp} \cdot$$

Table 3-10 k_{def} for solid wood, glued-laminated timber and cross-laminated timber

Building material	k_{def} for utilisation class		
	1	2	3
Solid wood	0,60	0,80	2,00
Glued-laminated timber			
Cross-laminated timber ¹	0,80	1,00	not approved

$$w_{creep} = k_{def} \cdot w_{inst,qp} \quad (3.3)$$

¹ This determination is based on analyses of TU Graz (Graz University of Technology). See Jöbstl und Schickhofer (2007).

Determinations made in other documents are:

Building material	k_{def} for utilisation class		
	1	2	3
Plywood according to EN 1995-1-1:2009	0,80	1,00	2,50
laminated timber according to DIN 1052:2008	0,60	0,80	-
laminated timber TU Graz 3 to 7 layers	0,80	1,00	-
laminated timber TU Graz more than 7 layers	0,85	1,00	-

4 Cross-sectional values

The calculation of cross-sectional values as a basis for limit state verifications is discussed in the following chapter.

If there is a dominating direction of load distribution, cross-laminated timber elements may be treated as panel strips. For that, the cross-sectional values for a uniaxially stressed (normally one metre wide) beam are determined. The verifications in the ultimate limit states may be analysed with net cross-sectional values without considering shear flexibility, while for the serviceability limit states, shear flexibility must be considered via effective cross-sectional values (for example according to the Gamma method).

In cases deviating from uniaxial load distribution – as for example point support, angular support, openings, local subarea loads and the like – the biaxial load-bearing effect of the panel must be considered. For that, the two most common models *grillage* and *orthotropic panel* are discussed.

Concludingly, the cross-sectional values for cross-laminated timber as a plate are stated.

The general determination applies, that the modulus of elasticity of the boards transverse to the fibre is assumed with $E_{90} = 0$.

4.1 Beams – Net cross-sectional values

In the following, the determination of the cross-sectional values for the main direction of span 0 is demonstrated. If needed, the cross-sectional values for the ancillary direction of span 90 are determined analogously. Then, the transverse outer layers are not considered.

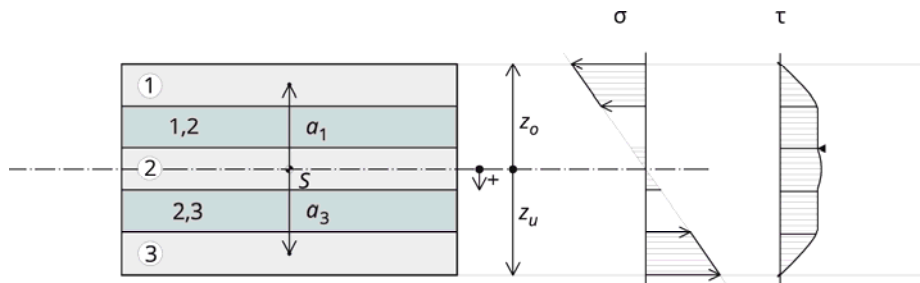

Figure 4-1: Symmetrical cross-section: designation of layers and dimensions

4.1.1 Centre of gravity

For structural design in the cold state, for symmetrical element build-ups, the position of the centre of gravity is determined with the axis of symmetry. For unsymmetrical cross-sections, as resulting due to different strength classes, glued-on timber-based materials, reductions in cross-section or following charring, the position of the centre of gravity shown in Figure 4-2 must be determined as follows:

1. For cross-sections from layers with different moduli of elasticity: choose reference modulus E_c .
2. Determine the position of the centre of gravity o_i of the individual layers from the element's upper edge.
3. Calculate the overall centre of gravity:

$$z_s = \frac{\sum_{i=1}^n \frac{E_i}{E_c} \cdot b_i \cdot d_i \cdot o_i}{\sum_{i=1}^n \frac{E_i}{E_c} \cdot b \cdot d_i} \quad (4.1)$$

4. Determine the distance of the centre of gravity a_i of the individual layers from the overall centre of gravity S :

$$a_i = o_i - z_s \quad (4.2)$$

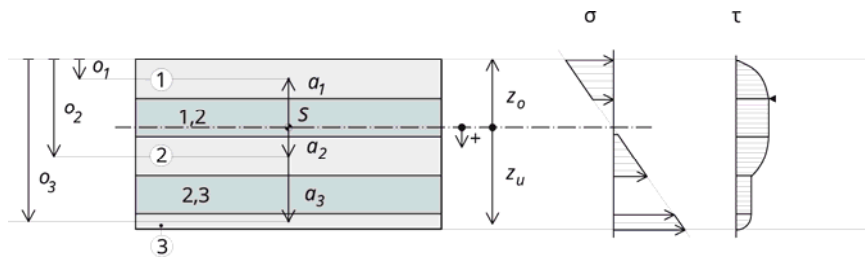

Figure 4-2: Unsymmetrical cross-section: Designation of the cross-sectional dimensions and basic representation of the stress curves

n Number of longitudinal layers

4.1.2 Area

$$A_{0,net} = \sum_{i=1}^n \frac{E_i}{E_c} \cdot b \cdot d_i \quad \text{..... Area (net)} \quad (4.3)$$

4.1.3 Section Modulus

$$W_{0,net} = \frac{I_{0,net}}{\max\{|z_o|; |z_u|\}} \quad \text{..... Section modulus (net)} \quad (4.4)$$

With the net moment of inertia

$$I_{0,net} = \sum_{i=1}^n \frac{E_i}{E_c} \cdot \frac{b \cdot d_i^3}{12} + \sum_{i=1}^n \frac{E_i}{E_c} \cdot b \cdot d_i \cdot a_i^2 \quad (4.5)$$

$z_o = z_s$ Distance of the top edge fibre to the overall centre of gravity

$z_u = d - |z_s|$ Distance of the bottom edge fibre to the overall centre of gravity

The following applies to the determination of stresses:

$$\sigma_{m,d} = \frac{E_i}{E_c} \cdot \frac{M_{y,d}}{W_{0,net}} \tag{4.6}$$

4.1.4 Static moment

The shear capacity is generally determined by the rolling shear strength of the transverse layers.

The associated static moment is

$$S_{R,0,net} = \sum_{i=1}^{m_L} \frac{E_i}{E_c} \cdot b \cdot d_i \cdot a_i \text{ Static moment (rolling shear)} \tag{4.7}$$

m_L Index of that longitudinal layer closest to the position of the centre of gravity – as seen from the top edge of the cross-section.

For reasons of equilibrium, the shear stress in the transverse layers is constant, as shown in Figure 4-2.

Note: For elements with cross-section build-ups stacked in a special fashion or with different strength classes, the shear failure can be determined from the shear strength of the longitudinal layer closest to the centre of gravity and not from the rolling shear strength of the transverse layer closest to the centre of gravity. The associated static moment must be determined as follows.

If the centre of gravity is located in the affected longitudinal layer:

$$S_{0,net} = \sum_{i=1}^{k_L} \frac{E_i}{E_c} \cdot b \cdot d_i \cdot a_i + b \cdot \frac{\left(\frac{d_k}{2} - a_k\right)^2}{2} \text{ Static moment (shear)} \tag{4.8}$$

a_k Distance of the centre of gravity in the layer including the centre of gravity

d_k Thickness of the layer including the centre of gravity

If the centre of gravity is not located in the affected longitudinal layer:

$$S_{0,net} = \sum_{i=1}^{k_L} \frac{E_i}{E_c} \cdot b \cdot d_i \cdot a_i \text{ Static moment (shear)} \tag{4.9}$$

k_L Index of the longitudinal layer closest to the centre of gravity as seen from the top edge of the cross-section

4.1.5 Radius of inertia

For structural elements with a risk of buckling, the influence of shear flexibility must be considered for the verification against buckling from the element plane. This can be considered with the effective moment of inertia I_{ef} according to 4.2. (Gamma method). Then, the buckling length ℓ_{ki} must be assumed as the reference length ℓ_{ref} .

$$i_{y,ef} = \sqrt{\frac{I_{0,ef}}{A_{0,net}}} \dots\dots\dots \text{Effective radius of inertia} \quad (4.10)$$

Buckling about the z-axis must only be considered for very narrow wall columns with a column width $h \leq 3,50 \cdot i_{y,ef}$.

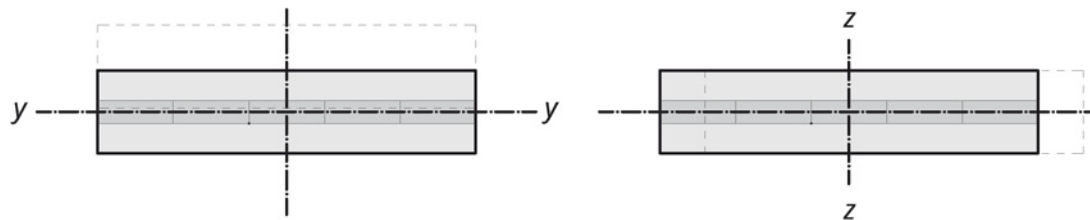

4.1.6 Torsional resistance

The torsional resistance of cross-laminated timber depends on the cross-section build-up and the element width and was discussed by Silly (2010).

The **moment of torsional resistance** of homogeneous rectangular cross-sections is

$$W_T = \frac{c_1}{c_2} \cdot \frac{d^2 h}{3} \quad (4.11)$$

with the factors

$$c_1 = 1 - 0,63 \cdot \frac{d}{h} + 0,052 \cdot \left(\frac{d}{h}\right)^5 \quad (4.12)$$

$$c_2 = 1 - \frac{0,65 \cdot \left(\frac{d}{h}\right)^3}{1 + \left(\frac{d}{h}\right)^3} \quad (4.13)$$

Upon using cross-laminated timber as an upright girder, with a risk of tilting, the **torsional moment of inertia** of the gross cross-section, which is considered homogeneous, can be approximately used with reduction of the torsional stiffness according to Silly (2010).

$$I_{T,CLT} \approx 0,65 \cdot I_T = 0,65 \cdot c_1 \frac{d^3 \cdot h}{3} \quad (4.14)$$

$$c_1 = 1 - 0,63 \cdot \frac{d}{h} + 0,052 \cdot \left(\frac{d}{h}\right)^5 \quad (4.15)$$

4.1.7 Polar moment of inertia of glued surfaces

For design with shear stress in the element plane (plate), different failure mechanisms according to Section 5.8 are considered. An associated cross-sectional value is the polar moment of resistance of the glued surfaces.

Polar moment of inertia

The polar moment of inertia applies to linear stress distribution of the torsional shearing stresses from the centre of the rectangular glued surface up to the outer edge. The polar moment of inertia I_p is slightly larger than the torsional moment of inertia I_t , since upon torsion of members, the shearing stresses are not linear.

$$I_p = I_1 + I_2 = \frac{a_1 \cdot a_2^3}{12} + \frac{a_1^3 \cdot a_2}{12} \tag{4.16}$$

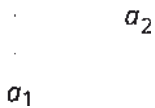

For square intersection areas

$$I_p = \frac{a^4}{6} \tag{4.17}$$

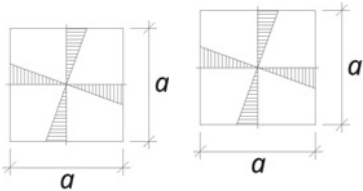

a Assumed board width. Normally, a mean width of $a = 80$ mm is assumed (also see Section 5.8).

Polar moment of resistance

For determination of the torsional shearing stresses in the glued intersection areas, the polar moment of resistance is required.

In general,

$$W_p = \frac{2I_p}{a} \tag{4.18}$$

For square intersection areas results

$$W_p = \frac{a^3}{3} \tag{4.19}$$

4.2 Beams – Effective cross-sectional values

As described in the introduction, the influence of shear deformations on the overall deformation must be considered. In the present guideline, the Gamma method is used for that, and the shear deformation is considered in a simplified manner via an increased bending deformation. Thus, contrary to the pure flexural stiffness of the net cross-section EI_{net} , an effective moment of inertia I_{ef} is used for calculation.

The Gamma method according to Eurocode 5

The formulas for the Gamma method were edited in Eurocode 5¹ such that they can be applied unchanged for cases with two as well as three longitudinal layers. Theoretically, in both cases, the second longitudinal layer from the top is retained, as shown in Figure 4-3 with a thicker edge. The adjacent layers are flexibly linked to it and their respective Steiner portion reduced by a Gamma value depending on the span. For cross-sections with two longitudinal layers, the associated formulas result in unsymmetrical intermediate results.

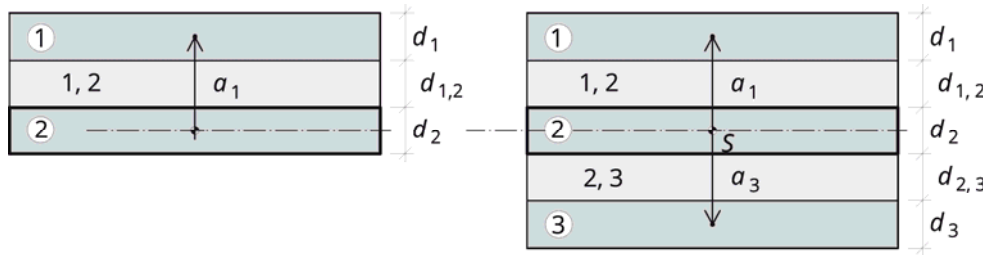

Figure 4-3: Distances in the Gamma method according to Eurocode 5

$$\gamma_1 = \frac{1}{\left(1 + \frac{\pi^2 \cdot E_1 \cdot A_1 \cdot d_{1,2}}{\ell_{ref}^2 \cdot b \cdot G_{R,12}}\right)} \left[\frac{1}{m} \right] \quad (4.20)$$

$$\gamma_2 = 1,0 \left[\frac{1}{m} \right]$$

$$\gamma_3 = \frac{1}{\left(1 + \frac{\pi^2 \cdot E_3 \cdot A_3 \cdot d_{2,3}}{\ell_{ref}^2 \cdot b \cdot G_{R,23}}\right)} \left[\frac{1}{m} \right] \quad (4.21)$$

$$a_2 = \frac{\gamma_1 \cdot \frac{E_1}{E_c} \cdot b \cdot d_1 \cdot \left(\frac{d_1}{2} + d_{1,2} + \frac{d_2}{2}\right) - \gamma_3 \cdot \frac{E_3}{E_c} \cdot b \cdot d_3 \cdot \left(\frac{d_2}{2} + d_{2,3} + \frac{d_3}{2}\right)}{\sum_{i=1}^3 \gamma_i \cdot \frac{E_i}{E_c} \cdot b \cdot d_i} \quad (4.22)$$

$$a_1 = \left(\frac{d_1}{2} + d_{1,2} + \frac{d_2}{2}\right) - a_2 \quad (4.23)$$

$$a_3 = \left(\frac{d_2}{2} + d_{2,3} + \frac{d_3}{2}\right) + a_2 \quad (4.24)$$

$$I_{0,ef} = \frac{\sum_{i=1}^3 \frac{E_i}{E_c} \cdot \frac{b \cdot d_i^3}{12} + \sum_{i=1}^3 \gamma_i \cdot \frac{E_i}{E_c} \cdot b \cdot d_i \cdot a_i^2}{\quad} \quad (4.25)$$

¹ EN 1995-1-1, Annex B: Flexibly connected flexural members.

Assumption of the reference lengths:

Single-span girders: $l_{ref} = l$

Continuous girders: $l_{ref} = \frac{4}{5} l_{min} = 0,8 \cdot l_{min}$

Cantilevers: $l_{ref} = 2 \cdot l$

Buckling members: $l_{ref} = l_{ki}$

The modified Gamma method

For cross-sections with more than three longitudinal layers, i.e. seven- or nine-layer build-ups, the modified Gamma method must be applied, as stated in Annex A.1.

Alternatively, shear deformations can be considered via a shear-flexible, layered beam according to Timoshenko, as described in Annex A.2.

4.3 Biaxial load-bearing effect of panels

As mentioned in the introduction, upon deviation from the outline conditions for uniaxial load distribution, the biaxial load-bearing effect of panels must be considered. In the following, suitable models with respective stiffness values to be applied are described in order to determine internal panel forces from the impacts. Since the determination of stresses considering the individual layers is not included in the models described, it is recommended to perform the verifications in the ultimate limit states at internal force level.

4.3.1 Orthotropic panels with effective thicknesses

The effective moments of inertia in both directions $I_{y,ef} = I_{0,ef}$ and $I_{x,ef} = I_{90,ef}$ are determined and recalculated into effective panel thicknesses $d_{y,ef}$ and $d_{x,ef}$.

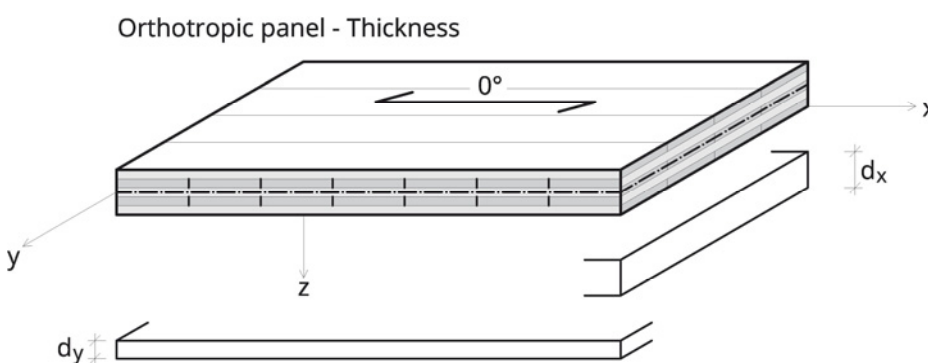

Figure 4-4: Substitute thicknesses for orthotropic panels

$$d_{y,ef} = \sqrt[3]{\frac{12 \cdot I_{0,ef}}{100}} \quad (4.26)$$

$$d_{x,ef} = \sqrt[3]{\frac{12 \cdot I_{90,ef}}{100}} \quad (4.27)$$

$I_{0,ef} = I_{y,ef}$ Moment of inertia about an axis transverse to the main direction of load-bearing capacity [cm⁴]

$I_{90,ef} = I_{x,ef}$ Moment of inertia about an axis transverse to the ancillary direction of load-bearing capacity [cm⁴]

In most EDP programmes, the torsional stiffness of the panel is recalculated from the flexural stiffnesses as follows:

$$K_{x,y} = \frac{\sqrt{EI_{0,ef} \cdot EI_{90,ef}}}{2} \quad (4.28)$$

Therewith, the torsional stiffness for cross-laminated timber is estimated too high. From a scientifically safe point of view, reduction of this torsional stiffness recalculated from flexural stiffnesses to about 50 % for three and to 25 % for five layers is recommended.

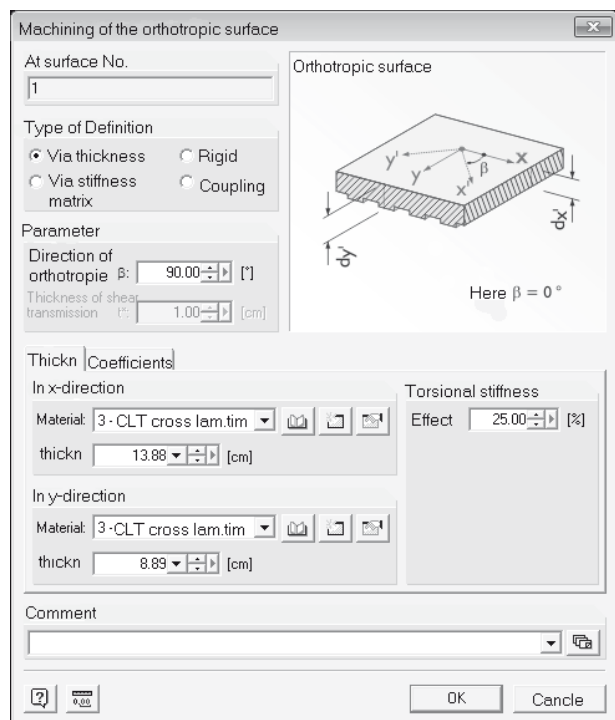

Figure 4-5: Input of substitute thicknesses in two directions¹

¹ Programme system RFEM, Dlubal GmbH.

4.3.2 Orthotropic panels with direct statement of stiffnesses

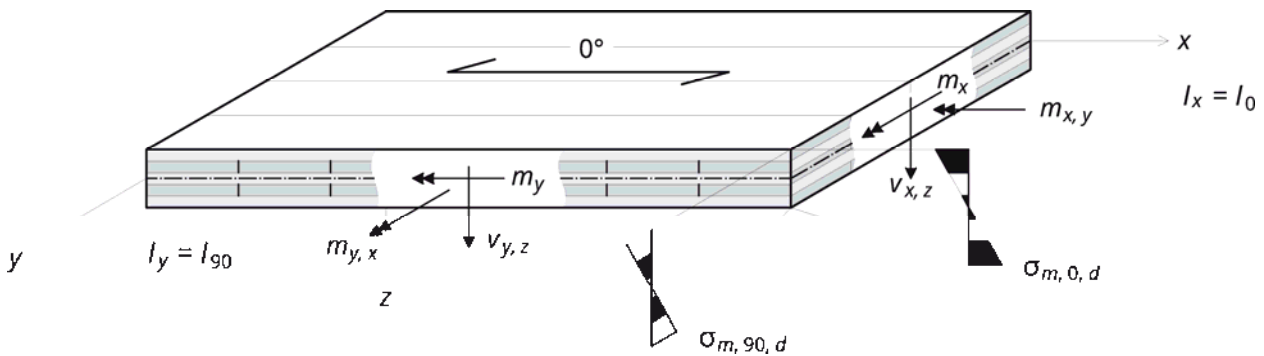

Figure 4-6: Designation of axes, internal forces and stresses

On the basis of the Timoshenko beam with the shear correction coefficient according to Annex A.2., the stiffnesses of shear-flexible panels can be determined independent of the static system with cross-sectional values in both directions (according to Reissner-Mindlin).

The individual stiffnesses are calculated as follows:

$$K_x = D_{1,1} = \frac{E_{0,mean} \cdot I_{0,net}}{(1 - \nu_{x,y} \cdot \nu_{y,x})} \dots\dots\dots \text{Flexural stiffness in x-direction [kNm}^2\text{/m]}$$

Normally $K_x = D_{1,1} = E_{0,mean} \cdot I_{0,ef}$ is assumed.

$$K_y = D_{2,2} = \frac{E_{0,mean} \cdot I_{90,net}}{(1 - \nu_{x,y} \cdot \nu_{y,x})} \dots\dots\dots \text{Flexural stiffness in y-direction [kNm}^2\text{/m].}$$

Normally $K_y = D_{2,2} = E_{0,mean} \cdot I_{90,ef}$ is assumed.

$$K_v = D_{1,2} = D_{2,1} = \sqrt{\nu_{x,y} \cdot \nu_{y,x} \cdot K_x \cdot K_y} \dots\dots\dots \text{Influence on the bending moments by transverse expansion [kNm}^2\text{/m]. Normally } K_v = D_{1,2} = D_{2,1} = 0 \text{ is assumed.}$$

$\nu_{x,y}, \nu_{y,x}$ Coefficients of transverse expansion of timber.

Normally $\nu_{x,y} = \nu_{y,x} = 0$ is assumed.

$$K_{x,y} = D_{3,3} = K_{tors} \cdot G_{0,mean} \cdot \frac{b \cdot d^3}{12} \dots\dots\dots \text{Torsional stiffness [kNm}^2\text{/m]}$$

$K_{tors} \approx 0,65$ Reduction factor for reduction of torsional stiffness¹

$$S_x = D_{4,4} = \frac{1}{K_{0,z}} \cdot G_{0,mean} \cdot A_{0,net} \dots\dots\dots \text{Shear stiffness upon stress by } \nu_{x,z} \text{ [kN/m]}$$

$$S_y = D_{5,5} = \frac{1}{K_{90,z}} \cdot G_{0,mean} \cdot A_{90,net} \dots\dots\dots \text{Shear stiffness upon stress by } \nu_{y,z} \text{ [kN/m]}$$

$K_{0,z}$ Shear correction coefficient according to Annex A.2. upon consideration in the direction of the top layers

$K_{90,z}$ Shear correction coefficient according to Annex A.2. upon consideration transverse to the top layers

¹ Silly (2010). Without cracks, first a factor of 0,80 is assumed. Considering cracks, the factor 0,65 is recommended.

The stiffness matrix then is

$$C_{Panel} = \begin{bmatrix} D_{1,1} & D_{1,2} & 0 & 0 & 0 \\ D_{2,1} & D_{2,2} & 0 & 0 & 0 \\ 0 & 0 & D_{3,3} & 0 & 0 \\ 0 & 0 & 0 & D_{4,4} & 0 \\ 0 & 0 & 0 & 0 & D_{5,5} \end{bmatrix} \quad (4.29)$$

and the relation between forces and displacements is

$$\begin{Bmatrix} m_x \\ m_y \\ m_{xy} \\ v_x \\ v_y \end{Bmatrix} = C_{Panel} \cdot \begin{Bmatrix} \frac{\partial \phi_y}{\partial x} \\ -\frac{\partial \phi_x}{\partial y} \\ \frac{\partial \phi_y}{\partial y} - \frac{\partial \phi_x}{\partial x} \\ \frac{\partial u_z}{\partial x} + \phi_y \\ \frac{\partial u_z}{\partial y} - \phi_x \end{Bmatrix} \quad (4.30)$$

One example for input via a user interface is shown in Figure 4-7.

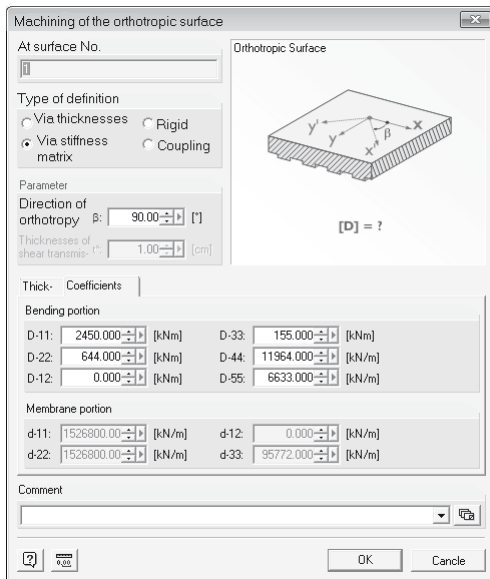

Figure 4-7: Input of the coefficients of the stiffness matrix for panels (software package RFEM, Dlubal GmbH)

4.3.3 Orthotropic panels – Verification

As described in Section 4.3, it is reasonable to perform the load-bearing capacity verifications for panels at the internal force level. Designations of the internal forces can be retrieved from Figure 4-6.

Stress in sections transverse to the top layer (main direction of load-bearing capacity x)

Bending moments

$$m_{x,S,d} \leq m_{x,R,d} \tag{4.31}$$

$m_{x,S,d}$ Design value of impact (bending moment per running metre) [kNm/m]

$m_{x,R,d}$ Design value of resistance (for a one-metre strip) [kNm/m]

$$m_{x,R,d} = W_{0,net} \cdot f_{m,d}$$

Lateral forces

$$V_{x,z,S,d} \leq V_{x,z,R,d} \tag{4.32}$$

$V_{x,z,S,d}$ Design value of impact (lateral force per running metre) [kN/m]

$V_{x,z,R,d}$ Design value of resistance (for a one-metre strip) [kN/m]

$$V_{x,z,R,d} = \frac{I_{0,net} \cdot 1m}{S_{R,0,net}} \cdot f_{V,R,d}$$

Stress in sections in the direction of the top layer (ancillary direction of load-bearing capacity y)

Bending moments

$$m_{y,S,d} \leq m_{y,R,d} \tag{4.33}$$

$m_{y,S,d}$ Design value of impact (bending moment per running metre) [kNm/m]

$m_{y,R,d}$ Design value of resistance (for a one-metre strip) [kNm/m]

$$m_{y,R,d} = W_{90,net} \cdot f_{m,d}$$

Lateral forces

$$V_{y,z,S,d} \leq V_{y,z,R,d} \tag{4.34}$$

$V_{y,z,S,d}$ Design value of impact (lateral force per running metre) [kN/m]

$V_{y,z,R,d}$ Design value of resistance (for a one-metre strip) [kN/m]

$$V_{y,z,R,d} = \frac{I_{90,net} \cdot 1m}{S_{R,90,net}} \cdot f_{V,R,d}$$

Torsional stress

$$m_{x,y,S,d} \leq m_{x,y,R,d} \tag{4.35}$$

$m_{x,y,S,d}$ Design value of impact (torsional moment per running metre) [kNm/m]

$m_{x,y,R,d}$ Design value of resistance for torsion (for a one-metre strip) [kNm/m]

$$m_{x,y,R,d} = W_{T,net} \cdot f_{V,d}$$

4.3.4 Grillage models

For calculation with a grillage model, cross-laminated timber is divided into a grid of members. Depending on specifications in the product approvals, which mostly refer to a rod-shaped standard element, a grid with the width of this reference member (normally 40 cm or 80 cm) is recommended. The grillage has to be modelled such that the supports are arranged along the outer edge of the element at a distance of half the grid size b . Only then the stiffness of the edge girders is modelled correctly.

In the grillage model, the influence of the relatively low torsional stiffness of cross-laminated timber is mostly neglected entirely. This normally results in slightly larger deflections and no lifting forces occur in the corners, as they prevail with torsionally stiff panels.

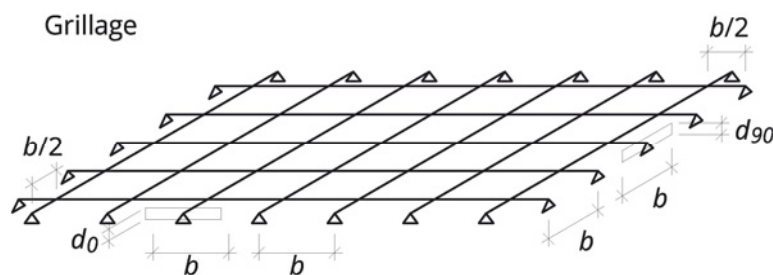

Figure 4-8: Grillage model

Shear deformations are normally considered via the effective moments of inertia according to the Gamma method. Determination of the reference lengths takes place according to the beam model with assumption of a reference length described above – which restricts application to simple static systems. For continuous and projecting systems, in a first approximation, the lowest stiffness may be chosen for the smallest reference length to be assumed.

$$d_{0,ef} = \frac{I_{gross}}{I_{0,ef}} \text{ for members in parallel to the top layer}$$

$$d_{90,ef} = \frac{I_{gross}}{I_{90,ef}} \text{ for members transverse to the top layer}$$

Note: Upon automatic determination, definition of the grillage cross-sections via effective element heights results in a lower dead weight of the panel. Therefore, the dead weight has to be defined as a permanent superimposed load.

As an alternative to shear-rigid members, a grillage of shear-flexible members may be used. Then, shear flexibility can be considered via a cross-section with a respective shear correction coefficient (according to A.2.) independent of the support conditions.

Results of the grillage calculation are deformations and internal forces in the panel strip. The verifications of load-bearing capacity must be undertaken with the net cross-sectional values according to Chapter 4. with the width b of the grid division.

4.4 Plates

4.4.1 Shear stiffness

According to Silly (2010), upon stressing as a plate, the shear stiffness of cross-laminated timber must be reduced compared to homogeneous material.

$$G_{S,mean} = \frac{1}{1 + 6 \cdot \alpha_{FE} \cdot \left(\frac{d_{mean}}{a}\right)^2} \cdot G_{0,mean} \approx 0,75 \cdot G_{0,mean} \quad (4.36)$$

$$\alpha_{FE} = 0,32 \cdot \left(\frac{d_{mean}}{a}\right)^{-0,77} \quad (4.37)$$

d_{mean} Average board thickness of the cross-section considered

a Assumed board width (150 mm is recommended)

The shear stiffness of the plate results in:

$$G \cdot A_S = G_{S,mean} \cdot A_{gross} \quad (4.38)$$

4.4.2 Plates as orthotropic elements

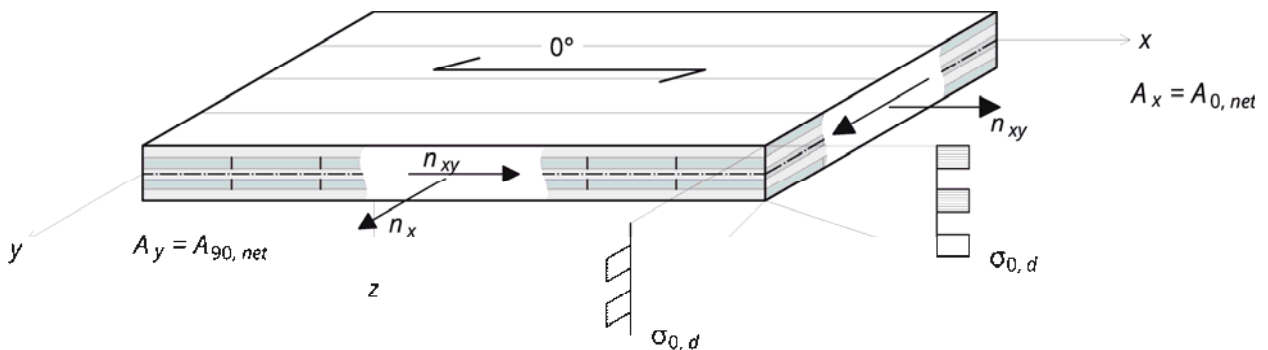

Figure 4-9: Internal force and designations for orthotropic plates

For calculation of cross-laminated timber plates, orthotropic finite elements can be used; the behaviour of the plate can also be defined via the stiffness matrix. The individual components of the stiffness matrix are

$D_x = d_{1,1} = E_{0,mean} \cdot A_{0,net}$ Extensional stiffness in the x-direction

$D_{x,y} = d_{1,2} = \nu \cdot D_x$ Influence on the longitudinal forces by transverse expansion

Normally $D_{x,y} = d_{1,2} = 0$ is assumed.

$D_y = d_{2,2} = E_{90,mean} \cdot A_{90,net}$ Extensional stiffness in the y-direction

$D_s = d_{3,3} = G_{S,mean} \cdot A_{gross} \approx 0,75 \cdot G_{0,mean} \cdot A_{gross}$

Shear stiffness according to 4.4.1.

The stiffness matrix of the plate then is

$$C_{plate} = \begin{bmatrix} d_{1,1} & d_{1,2} & 0 \\ d_{2,1} & d_{2,2} & 0 \\ 0 & 0 & d_{3,3} \end{bmatrix} \quad (4.39)$$

and the relation between forces and distances is

$$\begin{Bmatrix} n_x \\ n_y \\ n_{xy} \end{Bmatrix} = C_{plate} \cdot \begin{Bmatrix} \frac{\partial u_x}{\partial x} \\ \frac{\partial u_y}{\partial y} \\ \frac{\partial u_x}{\partial y} - \frac{\partial u_y}{\partial x} \end{Bmatrix} \quad (4.40)$$

One example for input via a user interface is shown in Figure 4-10.

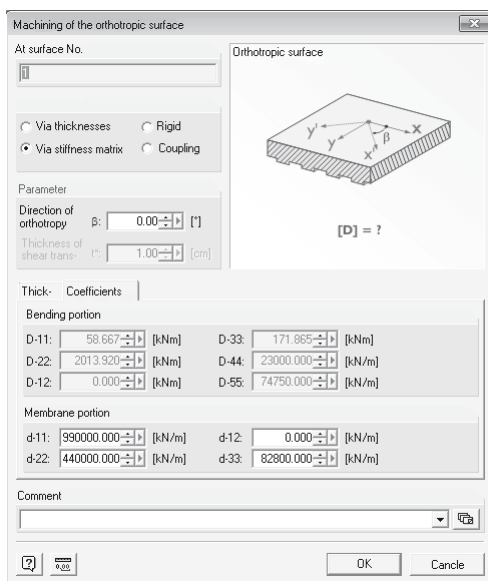

Figure 4-10: Input of the coefficients of the stiffness matrix for plates (software package RFEM, Dlubal GmbH)

4.4.3 Plates as orthotropic elements - Verification

As described in Section 4.3, it is reasonable to perform load-bearing capacity verifications for plates at internal force level. Designations of the internal forces can be retrieved from Figure 4-9.

Axial forces in sections transverse to the top layer (main direction of load-bearing capacity x)

$$n_{x,S,d} \leq n_{x,R,d} \quad (4.41)$$

$n_{x,S,d}$ Design value of impact (axial force per running metre) [kN/m]

$n_{x,R,d}$ Design value of resistance (for a one-metre strip) [kN/m]

with tensile stress: $n_{x,R,d} = A_{0,net} \cdot f_{t,0,d}$

with compressive stress: $n_{x,R,d} = A_{0,net} \cdot f_{c,0,d}$

Axial forces in sections in the direction of the top layer (ancillary direction of load-bearing capacity y)

$$n_{y,S,d} \leq n_{y,R,d} \quad (4.42)$$

$n_{y,S,d}$ Design value of impact (axial force per running metre) [kN/m]

$n_{y,R,d}$ Design value of resistance (for a one-metre strip) [kN/m]

with tensile stress: $n_{y,R,d} = A_{90,net} \cdot f_{t,0,d}$

with compressive stress: $n_{y,R,d} = A_{90,net} \cdot f_{c,0,d}$

Lateral forces

$$n_{x,y,S,d} \leq n_{x,y,R,d} \quad (4.43)$$

$n_{x,y,R,d}$ Design value of resistance (for a one-metre strip) [kN/m]

For verifications of plates subject to shear, see Section 5.8, page 57.

5 Ultimate limit states

5.1 Design situation

In the ultimate limit state, it must be verified that, at any point, the design value of stress is smaller than the design value of resistance, as described in Section 3.1 Design concept. Beside the cross-sectional load-bearing capacity at stress level, stability failure, like buckling and tilting, and fasteners must be analysed in the ultimate limit states.

Design situation

Rare design situation:

$$E_d = \sum_{i \geq 1} Y_G \cdot G_{k,i} \oplus Y_Q \cdot Q_{k,1} \oplus \sum_{i > 1} Y_{Q,i} \cdot \psi_{0,i} \cdot Q_{k,i} \quad (5.1)$$

Verification

$$\begin{aligned} E_d &\leq R_d \\ E_d &\leq k_{mod} \cdot \frac{R_k}{\gamma_m} \end{aligned} \quad (5.2)$$

Table 5-1 Partial safety factors in the ultimate limit state

Static equilibrium	unfavourable, destabilising, (superior)	favourable, stabilising (inferior)
Permanent impacts (dead weights, permanent superimposed loads)	$\gamma_{G,sup} = 1,35$	$\gamma_{G,inf} = 1,00$
Leading variable impacts (live loads, snow, wind)	$\gamma_{Q,sup} = 1,50$	$\gamma_{Q,inf} = 0,00$

5.2 Tension in the element plane

5.2.1 Tension in the direction of the top layers

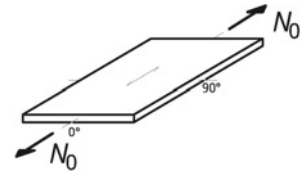

$$\sigma_{t,0,d} \leq f_{t,0,d} \quad (5.3)$$

$$\frac{N_{0,d}}{A_{0,net}} \leq k_{mod} \cdot k_{sys} \cdot \frac{f_{t,0,k}}{\gamma_m}$$

k_{sys} System coefficient according to Section 3.2.5

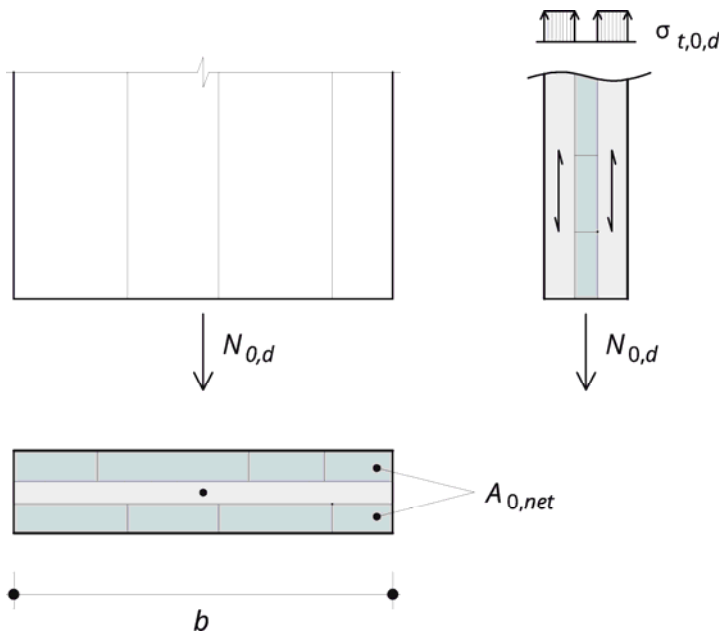

Figure 5-1: Tension in the direction of the top layers

5.2.2 Tension in the direction of the transverse layers

$$\sigma_{t,0,d} \leq f_{t,0,d}$$

$$\frac{N_{90,d}}{A_{90,net}} \leq k_{mod} \cdot k_{sys} \cdot \frac{f_{t,0,k}}{\gamma_m} \quad (5.4)$$

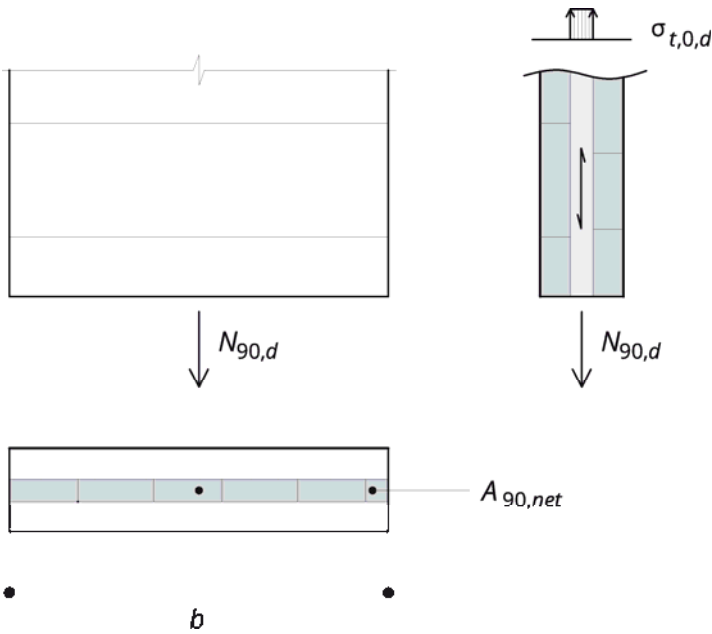
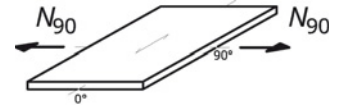
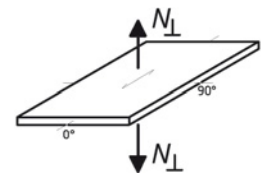

Figure 5-2: Tension in the direction of the transverse layers

5.3 Tension transverse to the element plane

Upon connection of tensile forces transverse to the element plane, the low transverse tensile load-bearing capacity must be observed. Best suited are connections, with which the force is transferred through the element and load application takes place under pressure on that side of the element facing away from the tensile force.



In case of a lower load level, fully threaded screws are suited, which are screwed into the entire element thickness, if possible. The connections described are shown in Figure 5-3.

Connections subject to tension must be analysed in the individual case.

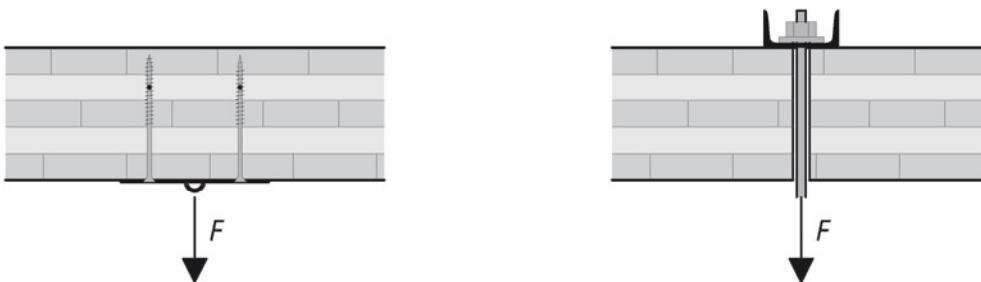

Figure 5-3: Design suggestions for suspending loads

5.4 Pressing of the front faces

Compressive forces to the lateral faces are absorbed by end pressing of the board layers running in the direction of force. For further transfer of locally introduced loads, possible failure mechanisms due to shearing stress or stability problems must be considered.

5.4.1 Pressure in the direction of the top layers

$$\sigma_{c,0,d} \leq f_{c,0,d} \quad (5.5)$$

$$\frac{N_{0,d}}{A_{0,net}} \leq k_{mod} \cdot \frac{f_{c,0,k}}{\gamma_m}$$

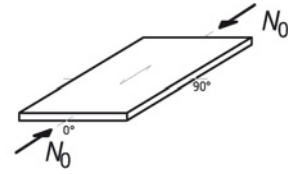

$$A_{0,net} = b \cdot d_{0,net} \quad \text{End pressing area}$$

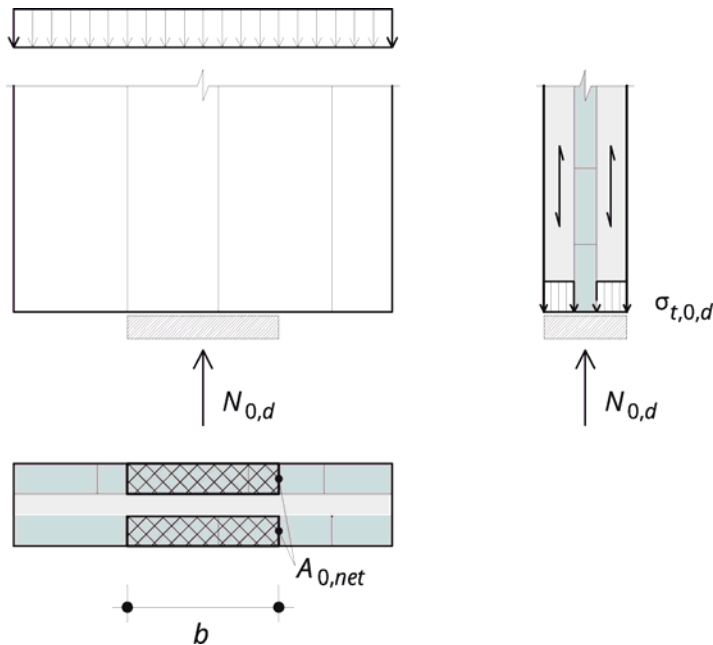
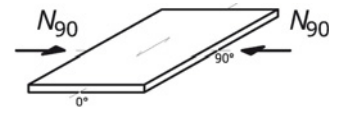

Figure 5-4: End pressing with pressing area of the vertical layers

Note: Load propagation into the element is discussed in Section 11.6 Shear walls.

5.4.2 Pressure in the direction of the transverse layers



$$\sigma_{c,0,d} \leq f_{c,0,d}$$

$$\frac{N_{90,d}}{A_{90,net}} \leq k_{mod} \cdot \frac{f_{c,0,k}}{\gamma_M} \quad (5.6)$$

$A_{90,net} = b \cdot d_{90,net}$ End pressing area

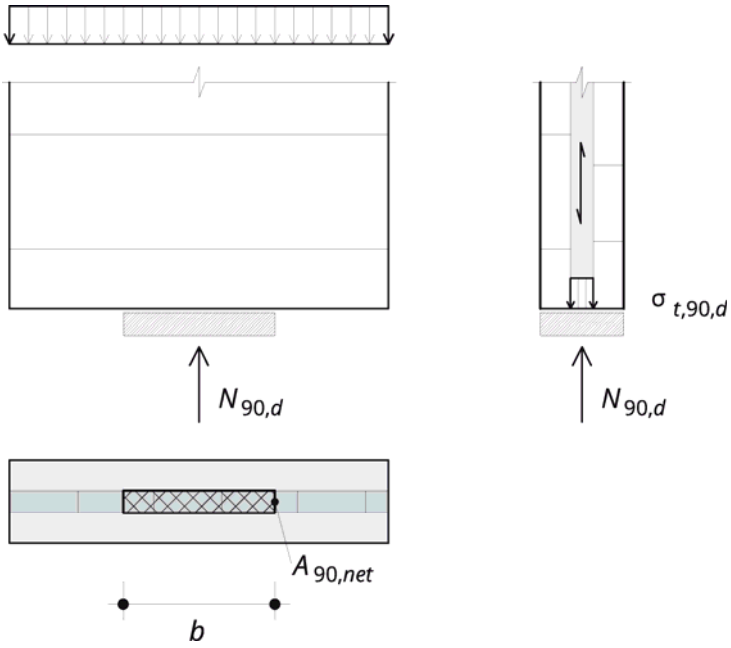

Figure 5-5: End pressing with pressing area of the vertical layers

5.4.3 Pressing transverse to the element plane

$$\sigma_{c,90,d} \leq f_{c,90,d}$$

$$\frac{N_{90,d}}{k_{c,90} \cdot A_{ef}} \leq k_{mod} \cdot \frac{f_{c,90,k}}{\gamma_M}$$

(5.7)

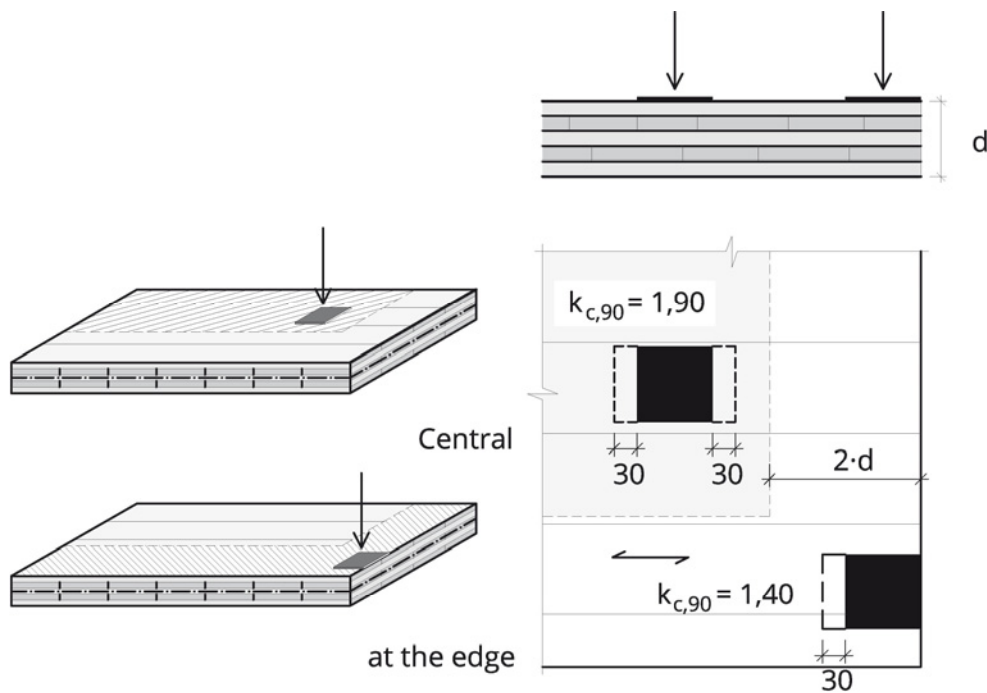
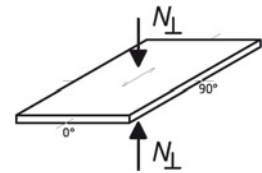

Figure 5-6: Areas for pressing of the element surface with associated coefficients and effective contact areas.

A_{ef} Effective contact area upon compressive stress on the element surface

In the direction of fibre of the top layers, the contact length may be increased by 30 mm on both sides, if at least 30 mm of step joint timber are present (see EN 1995-1-1, Section 6.1.5), as shown in Figure 5-7.

$k_{c,90}$ Coefficient for consideration of the outline conditions

To punctiform load application apply the coefficients according to Bogensperger et al. (2011) shown in Figure 5-6.

$k_{c,90} = 1,90$ For support away from the edge ($a \geq 2 \cdot d$)

$k_{c,90} = 1,40$ For support at the edge and in the corner

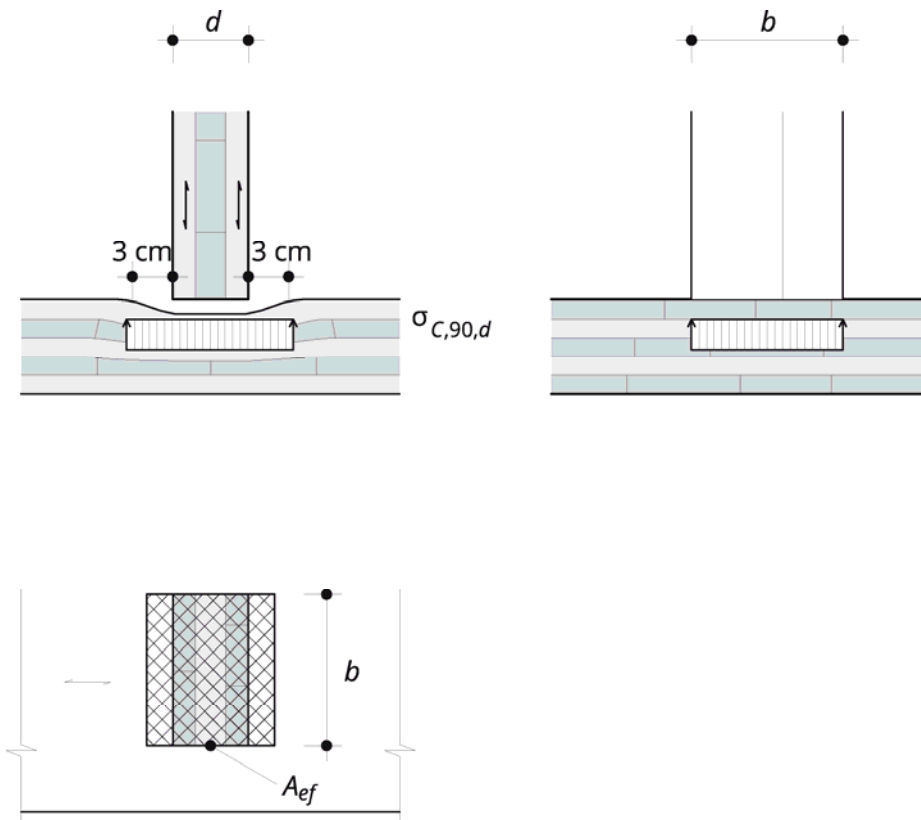

Figure 5-7: Load application into a ceiling element

5.5 Bending due to panel load

5.5.1 Bending in the main direction of load-bearing capacity

$$\sigma_{m,d} \leq f_{m,d} \quad (5.8)$$

$$\frac{M_{0,d}}{W_{0,net}} \leq k_{mod} \cdot k_{sys} \cdot \frac{f_{m,k}}{Y_m}$$

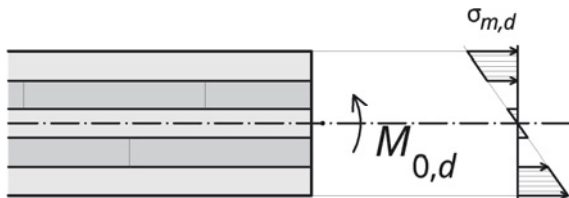
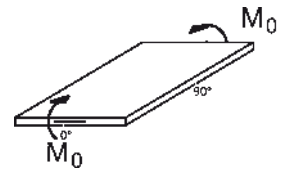

Figure 5-8: Bending in the main direction of load-bearing capacity

5.5.2 Bending in the ancillary direction of load-bearing capacity

$$\sigma_{m,d} \leq f_{m,d} \quad (5.9)$$

$$\frac{M_{90,d}}{W_{90,net}} \leq k_{mod} \cdot k_{sys} \cdot \frac{f_{m,k}}{Y_m}$$

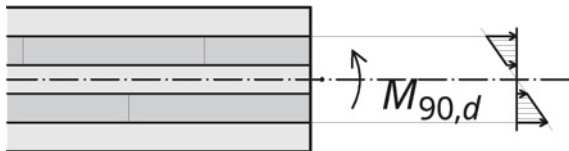

Figure 5-9: Bending in the ancillary direction of load-bearing capacity

5.6 Bending upon stressing as an upright girder

5.6.1 Top layer in the direction of load-bearing capacity

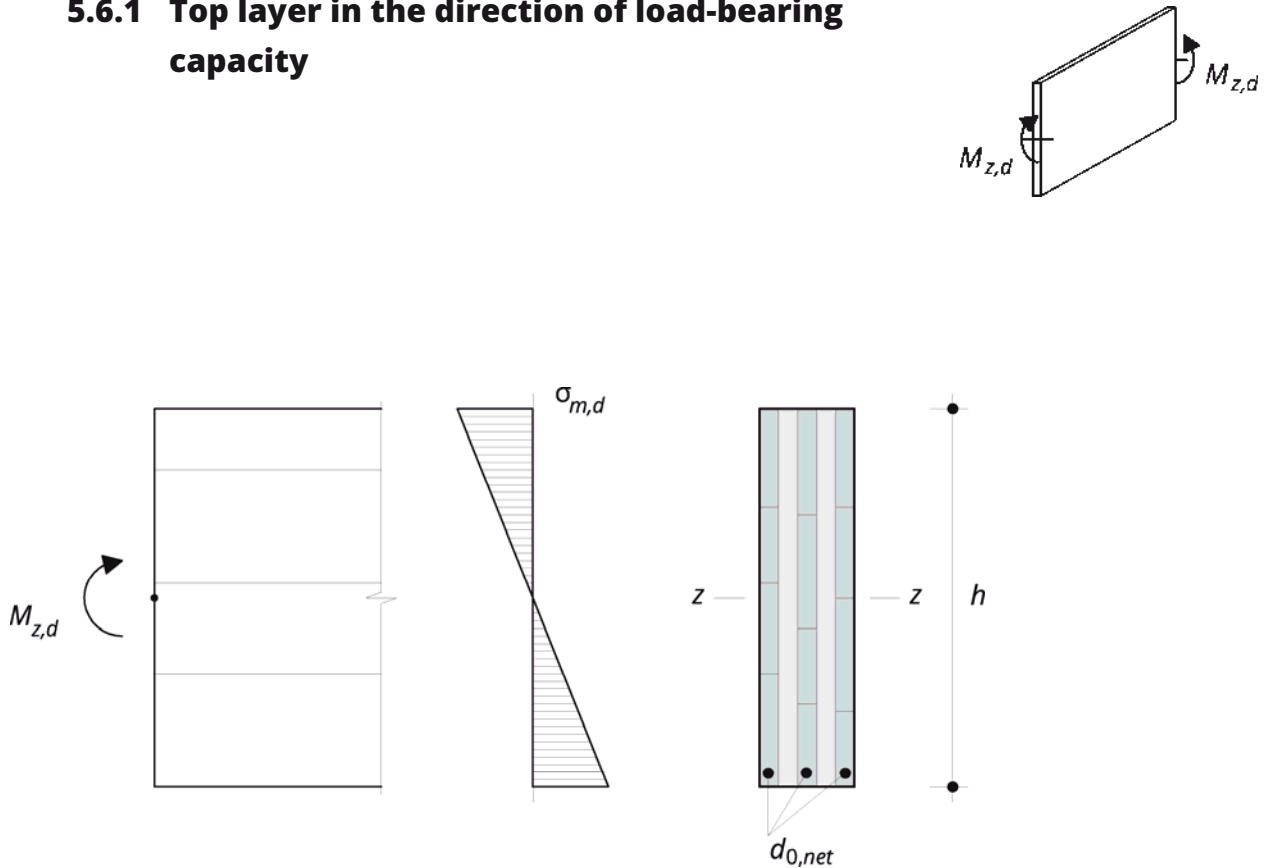

Figure 5-10: Bending stress for girders with a top layer in the direction of load-bearing capacity

$$\sigma_{m,z,d} \leq f_{m,d} \quad (5.10)$$

$$\frac{M_{z,d}}{W_{z,0,net}} \leq k_{mod} \cdot \frac{f_{m,k}}{Y_m}$$

$$W_{z,0,net} = \frac{\sum d_0 \cdot h^2}{6} \quad (5.11)$$

In that, it is assumed that, as in the currently valid product approvals, the boards of all layers under stress are connected by finger joints; blunt joints are inadmissible. Reductions in cross-section must be observed.

Note: With a declining ℓ/h ratio, the beam theory assuming linear stress distribution no longer applies. The tension zone becomes lower, the pressure zone higher. This deviation becomes noticeable from $\ell/h \leq 4$ on, at least from $\ell/h = 2$ it should be considered. Also see Section 11.6 Shear walls.

5.6.2 Top layer transverse to the direction of load-bearing capacity

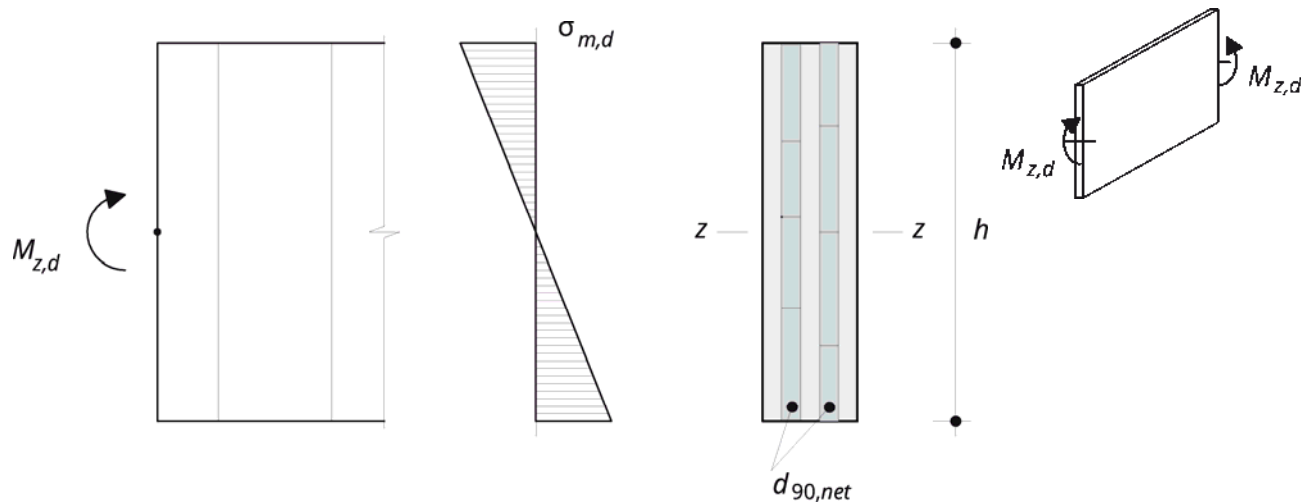

Figure 5-11: Bending stress for girders with a top layer transverse to the direction of load-bearing capacity

$$\sigma_{m,z,d} \leq f_{m,d} \tag{5.12}$$

$$\frac{M_{z,d}}{W_{z,90,net}} \leq k_{mod} \cdot \frac{f_{m,k}}{Y_m}$$

$$W_{z,0,net} = \frac{\sum d_{90} \cdot h^2}{6} \tag{5.13}$$

In that, it is assumed that, as in the currently valid product approvals, the boards of all layers under stress are connected by finger joints; blunt joints are inadmissible. Reductions in cross-section must be observed.

Note: With a declining ℓ/h ratio, the beam theory assuming linear stress distribution no longer applies. The tension zone becomes lower, the pressure zone higher. This deviation becomes noticeable from $\ell/h \leq 4$ on, at least from $\ell/h = 2$ it should be considered. Also see Section 11.6 Shear walls.

5.7 Shear upon stressing as a panel

5.7.1 Shear in the main direction of load-bearing capacity



Figure 5-12: Shear in the main direction of load-bearing capacity

$$\begin{aligned} \tau_{V,R,d} &\leq f_{V,R,d} \\ \frac{V_{0,d} \cdot S_{0,R,net}}{I_{0,net} \cdot b} &\leq k_{mod} \cdot \frac{f_{V,R,k}}{\gamma_M} \end{aligned} \quad (5.14)$$

In some cases, equivalent shear areas $A_{\tau,R,net}$ are stated in order to perform the verification of shear capacity analogously to the rectangular cross-section. The verification equation then is:

$$1,5 \cdot \frac{V_{0,d}}{A_{\tau,net}} \leq f_{V,R,d} \quad (5.15)$$

In that, $A_{\tau,net}$ was recalculated as follows

$$A_{\tau,net} = \frac{1,5 \cdot I_{0,net} \cdot b}{S_{0,R,net}} \quad (5.16)$$

Normally, the rolling shear strength of the transverse layer closest to the centre of gravity is decisive. For cross-laminated timber elements with special build-ups, the shear strength of the longitudinal layers must be additionally checked:

$$\begin{aligned} \tau_{V,d} &\leq f_{V,d} \\ \frac{V_{0,d} \cdot S_{0,V,net}}{I_{0,net} \cdot b} &\leq k_{mod} \cdot \frac{f_{V,k}}{\gamma_M} \end{aligned} \quad (5.17)$$

Note: Using the crack factor k_{cr} is not necessary, since cross-laminated timber is a two-dimensional element with an interlocked build-up and possible cracks are assumed considered via the product approvals.

5.7.2 Shear in the ancillary direction of load-bearing capacity

$$\tau_{V,R,d} \leq f_{V,R,d} \quad (5.18)$$

$$\frac{V_{90,d} \cdot S_{90,R,net}}{I_{90,net} \cdot b} \leq k_{mod} \cdot \frac{f_{V,R,k}}{\gamma_m}$$

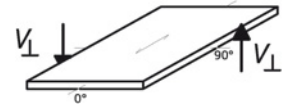

The comments on shear in the main directions of load-bearing capacity apply accordingly.

5.8 Shear upon stressing as a plate

Mechanisms for load-bearing capacity

The suggested failure mechanisms were taken from the current product approvals and documents.

Schickhofer et al. (2010)¹ developed an alternative design model not stated in the present guideline, which considers the stresses in cases of highly different layer thicknesses more exactly.

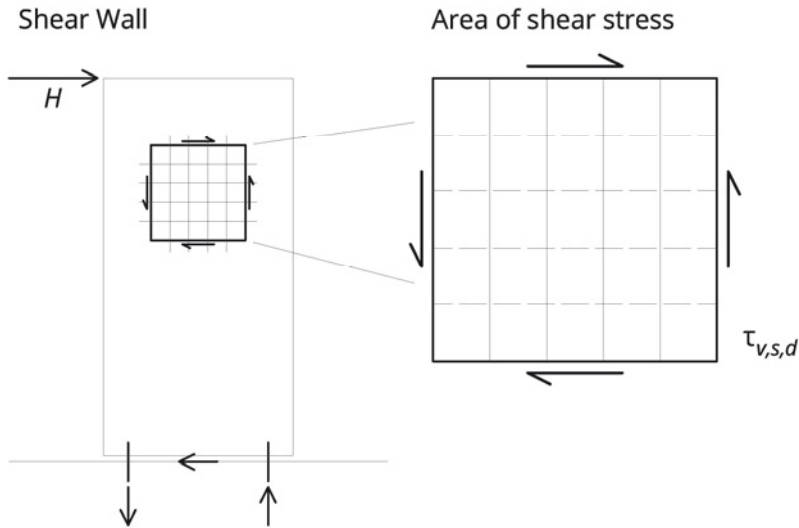
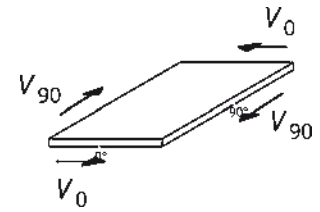

Figure 5-13: Shear within a shear wall

Mechanism 1: Shearing-off failure of the boards along a joint

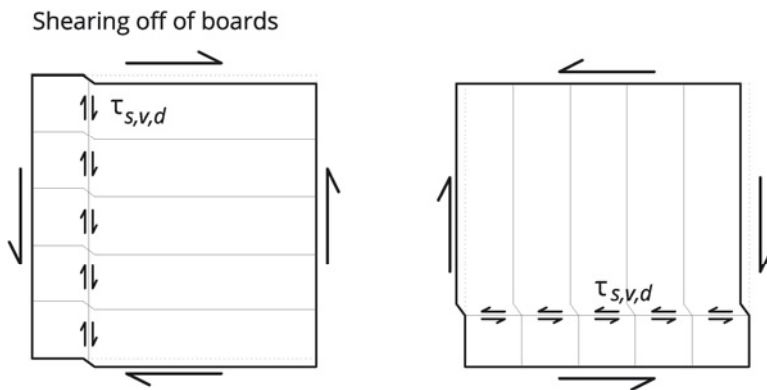

Figure 5-14: Shearing-off failure of the boards along a joint

¹ Chapter 7.

$$\tau_{V,S,d} \leq f_{V,S,d} \quad (5.19)$$

$$\tau_{V,S,d} = \frac{T}{A_{S,net}} \quad (5.20)$$

$$A_S = \min \begin{cases} A_{0,net} \\ A_{90,net} \end{cases} \quad (5.21)$$

Mechanism 2: Shearing failure of the glued surfaces in the intersection points

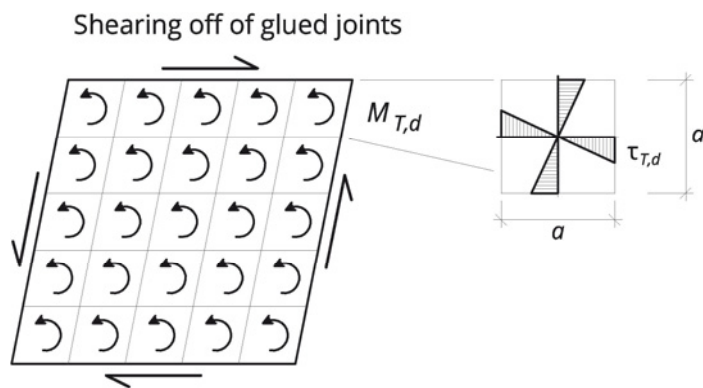

Figure 5-15: Shearing failure of the glued surfaces in the intersection points

$$\tau_{T,d} \leq f_{V,T,d} \quad (5.22)$$

$$\tau_{T,d} = \frac{M_T}{\sum I_p} \cdot \frac{a}{2} = \frac{M_T}{n_k \cdot \frac{a^4}{6}} \cdot \frac{a}{2} = \frac{3 \cdot M_T}{n_k \cdot a^3} \quad (5.23)$$

$M_T = T \cdot h$ Moment; shear force T times distance h to the joint considered

$I_p = \frac{a^4}{6}$ Polar moment of inertia of a square intersection field

a Board width
 (according to product standard: $a = 40$ mm to 300 mm, recommended:
 $a = 80$ mm)

n_k Number of glued surfaces
 $n_k = n_s \cdot n_f$

n_s Number of glued joints between layers positioned normal to one another
 (e.g. $n_s = 2$ for a three-layer element)

n_f Number of intersection fields

Mechanism 3: Shear failure of the entire plate

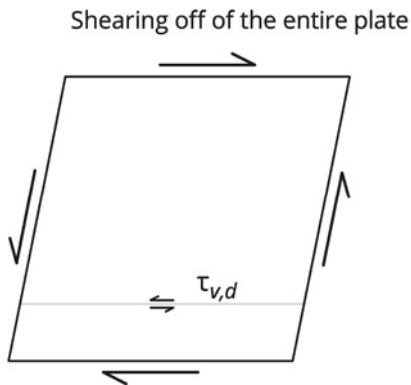

Figure 5-16: Shear failure of the entire plate

$$\tau_{V,d} \leq f_{V,d} \quad (5.24)$$

$$\tau_{V,d} = \frac{T}{A_{gross}} \quad (5.25)$$

Note: In case of local load application problems, in addition to shearing-off of board layers, failure by exceeding of the rolling shear strength may occur. Rolling shear stress occurs in the glued joints between those layers, into which the load is applied, and the layers oriented transverse thereto, via which the load is transferred further.

5.9 Torsion upon stressing as a panel

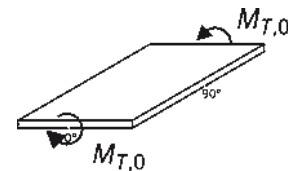

$$\tau_{T,d} \leq f_{T,d} \quad (5.26)$$

$$\frac{M_{T,d}}{W_T} \leq \frac{f_{T,k}}{\gamma_m}$$

Note: Upon modelling as an orthotropic panel, the occurring internal torsional forces $m_{x,y}$ depend on the torsional stiffness. The torsional stiffness of cross-laminated timber is discussed in Section 4.3.3. In practical structural design, a low torsional stiffness of about 40 % or less is applied for dimensioning.

5.10 Stability

5.10.1 Buckling upon pressure in the direction of the top layers

Buckling from the element plane

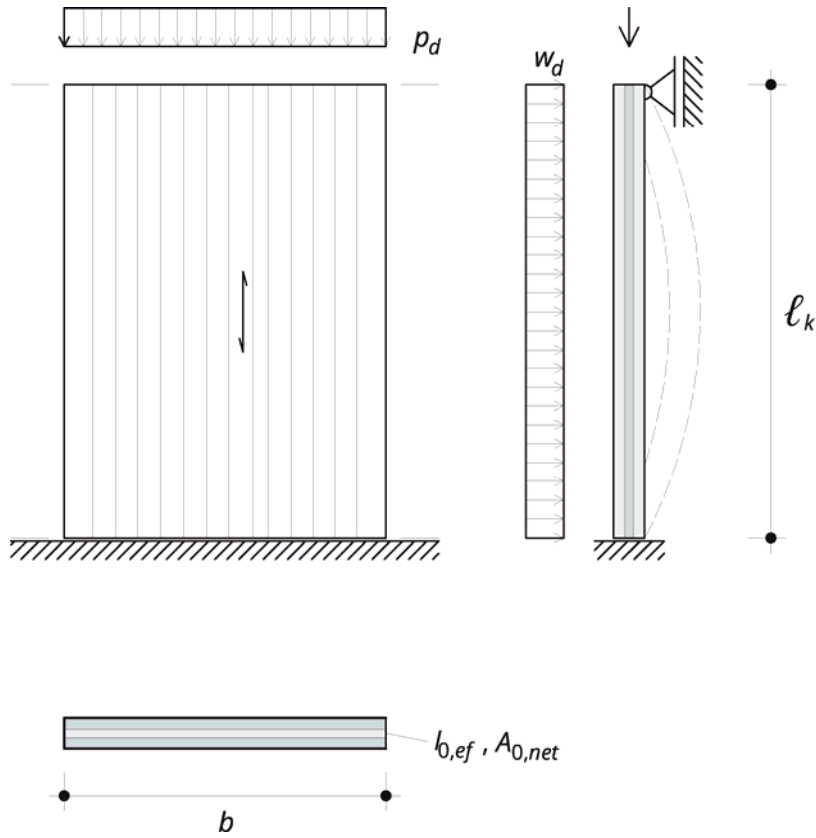

Figure 5-17: Buckling from the element plane

$$\frac{\sigma_{c,0,d}}{k_{c,y} \cdot f_{c,0,d}} + \frac{\sigma_{m,d}}{f_{m,d}} \leq 1 \quad (5.27)$$

$$\frac{\frac{N_d}{A_{net}}}{k_{c,y} \cdot f_{c,0,d}} + \frac{\frac{M_d}{W_{net}}}{f_{m,d}} \leq 1 \quad (5.28)$$

$$i_{y,0,ef} = \sqrt{\frac{I_{y,0,ef}}{A_{0,net}}} \quad (5.29)$$

$$\lambda_y = \frac{\ell_{k,i}}{i_{y,0,ef}} \quad (5.30)$$

Therein are

$k_{c,y}$ Buckling coefficient

$$k_{c,y} = \frac{1}{k_y + \sqrt{k_y^2 - \lambda_{rel,y}^2}}$$

k_y Buckling coefficient

$$k_y = 0,5 \left[(1 + \beta_c (\lambda_{rel,y} - 0,3) + \lambda_{rel,y}^2) \right]$$

β_c Coefficient of imperfection

$$\beta_c = 0,1 \text{ for cross-laminated timber}$$

$\lambda_{rel,y}$ Relative degree of slenderness for lateral buckling about the y-axis

$$\lambda_{rel,y} = \frac{\lambda_y}{\pi} \sqrt{\frac{f_{c,0,k}}{E_{0,05}}}$$

Table 5-2 Buckling coefficients $k_{c,y}$ for cross-laminated timber

λ	0	1	2	3	4	5	6	7	8	9
10	1,000									
20	0,999	0,998	0,996	0,994	0,992	0,991	0,989	0,987	0,985	0,983
30	0,981	0,978	0,976	0,974	0,971	0,969	0,966	0,963	0,960	0,957
40	0,954	0,951	0,947	0,944	0,940	0,936	0,931	0,926	0,922	0,916
50	0,911	0,905	0,898	0,892	0,885	0,877	0,869	0,860	0,851	0,842
60	0,832	0,822	0,811	0,799	0,788	0,776	0,763	0,751	0,738	0,725
70	0,712	0,699	0,686	0,673	0,660	0,647	0,634	0,622	0,609	0,597
80	0,585	0,574	0,562	0,551	0,540	0,529	0,519	0,508	0,498	0,489
90	0,479	0,470	0,461	0,452	0,443	0,435	0,427	0,419	0,411	0,403
100	0,396	0,389	0,382	0,375	0,368	0,362	0,355	0,349	0,343	0,337
110	0,332	0,326	0,320	0,315	0,310	0,305	0,300	0,295	0,290	0,286
120	0,281	0,277	0,272	0,268	0,264	0,260	0,256	0,252	0,248	0,245
130	0,241	0,238	0,234	0,231	0,227	0,224	0,221	0,218	0,215	0,212
140	0,209	0,206	0,203	0,201	0,198	0,195	0,193	0,190	0,188	0,185
150	0,183	0,180	0,178	0,176	0,174	0,172	0,169	0,167	0,165	0,163
160	0,161	0,159	0,157	0,156	0,154	0,152	0,150	0,148	0,147	0,145
170	0,143	0,142	0,140	0,138	0,137	0,135	0,134	0,132	0,131	0,130
180	0,128	0,127	0,125	0,124	0,123	0,121	0,120	0,119	0,118	0,116

Outline conditions: $E_{0,05} = 9.160 \text{ N/mm}^2$, $\beta_c = 0,1$

In general, in case of buckling, the shear flexibility of the transverse layers must be considered. Since their influence, however, normally is below 2 %, here it was neglected.

For structural design according to the substitute member method described, a limit slenderness of $\lambda_y \leq \lambda_{lim} = 150$ must be complied with. For the event of fire, a limit slenderness of $\lambda_{y,fi} \leq \lambda_{fi,lim} = 200$ is recommended.

Note: Load propagation of local point loads and supports is discussed in Section 11.6 Shear walls.

Buckling of wall columns

Upon execution of very narrow wall columns, it must be checked, whether buckling in the element plane, i.e. about the z-axis, becomes decisive.

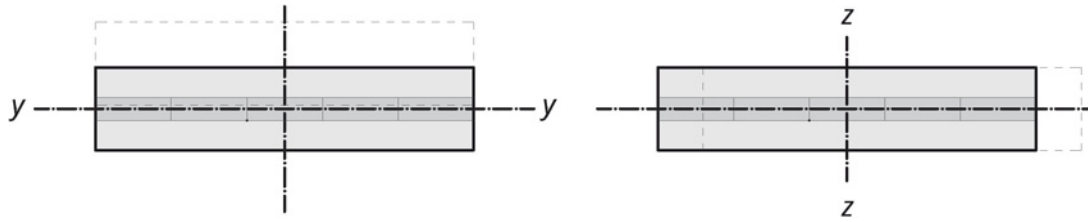

Figure 5-18: Axis designations

5.10.2 Buckling upon pressure in the direction of the transverse layers

Analogously to Section 5.10.1, with radius of inertia and slenderness for the ancillary direction of load-bearing capacity, the following applies:

$$i_{y,90,ef} = \sqrt{\frac{I_{y,90,ef}}{A_{90,net}}} \quad (5.31)$$

$$\lambda_y = \frac{\ell_{k,i}}{i_{y,90,ef}} \quad (5.32)$$

5.10.3 Tilting of upright cross-laminated timber girders

In case of narrow girders subject to bending, tilting, i.e. yielding of the compression flange, may occur as stability failure; with a combination of pressure and bending, this is called intorsion.

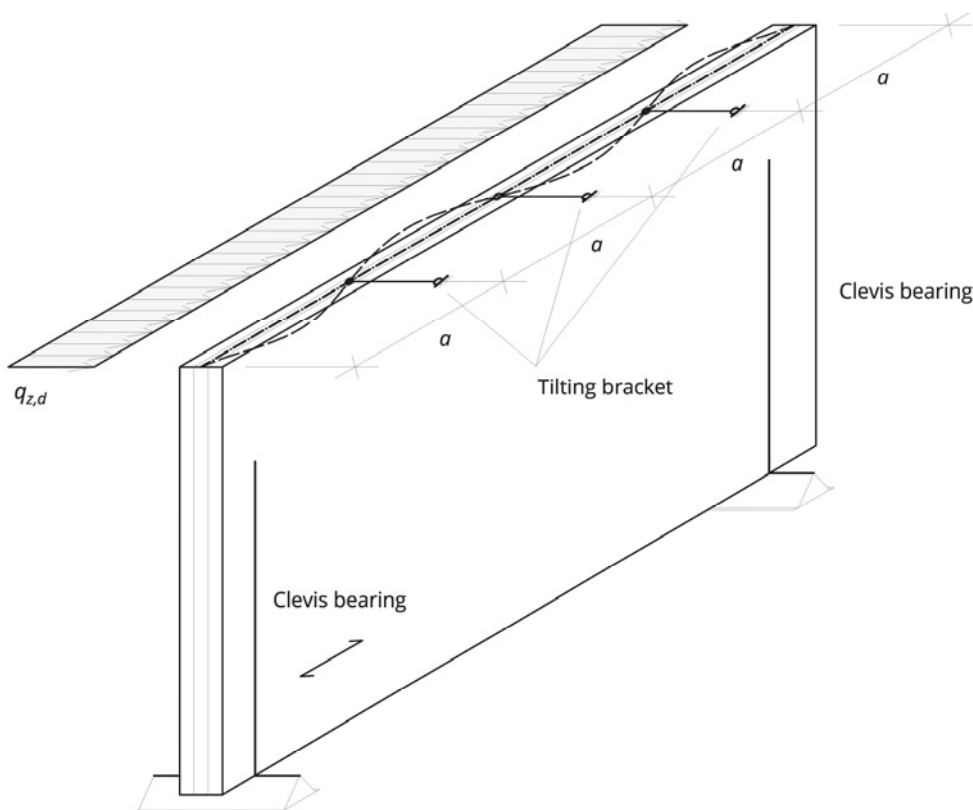

Figure 5-19: Tilting of an upright cross-laminated timber girder

The top flange in the span and the bottom flange across supports of continuous girders, i.e. that part of cross-laminated timber girders subject to pressure, should, if possible, be continuously held against lateral yielding.

If the compression flange is held only in a punctiform manner, as shown in Figure 5-19, then tilting verification according Eurocode 5¹ must be performed with the torsional moment of inertia of the circumscribed rectangle described in 4.1.6. The effective tilting length depends on the height of the load application (at the top or at the bottom of the girder) and on the moment distribution along the girder.

¹ Intorsion according to EN 1995-1-1, Section 6.3.3.

Clevis bearing

To girders continuously held against tilting, $k_{crit} = 1$ applies. Then, the clevis bearing has to be dimensioned for the design value of the torsional moment.

$$T_d = \frac{M_d}{80} \tag{5.33}$$

M_d Largest bending moment in the girder

Tilting bracket

According to Eurocode 5¹, the horizontal uniformly distributed load to be absorbed by tilting brackets can be determined as follows:

$$q_{z,d} = \min \left\{ 1; \sqrt{\frac{15}{\ell}} \right\} \cdot \frac{(1 - k_{crit}) \cdot M_d}{30 \cdot h \cdot \ell} \cdot n \tag{5.34}$$

k_{crit} Coefficient of tilting for consideration of the additional stresses as a consequence of lateral yielding upon assumption of missing tilting brackets in the span.

With practical construction dimensions (assumption: $\ell \leq 20 \text{ m}$; $h = \frac{\ell}{20}$; $d = \frac{h}{10}$) and cross-sectional values described in this guideline, the holding force (with $k_{crit} \approx 0,12$) can be limited as follows:

$$q_{z,d} \approx \frac{M_d}{40 \cdot h \cdot \ell} \cdot n \tag{5.35}$$

n Number of girders
 ℓ Length of the bracing [m]
 h Girder height [m]
 M_d Largest bending moment in the girder

5.10.4 Bulging

Walls linearly supported over their entire length must be treated as wall strips of buckling members. The stabilising effect of transverse walls is normally set aside.

Shear walls supported in a punctiform manner can, under the assumption of a load propagation angle according to Section 11.6, likewise be considered as wall strips and verified as buckling members. Occasionally, this results in very conservative design results. The exact consideration of the two-dimensional bulging failure provides considerably larger load-bearing reserves than the analysis of wall strips for buckling, if zones subject to pressure and tension are located next to one another.

¹ Bracing according to EN 1995-1-1, Section 9.5.2.

5.11 Combined stress

5.11.1 Bending and pressure

Without buckling risk

$$\frac{\sigma_{c,0,d}}{f_{c,0,d}} + \frac{\sigma_{m,d}}{f_{m,d}} \leq 1$$

$$\frac{N_{0,d}}{A_{0,net} \cdot f_{c,0,d}} + \frac{M_d}{W_{0,net} \cdot f_{m,d}} \leq 1 \quad (5.36)$$

5.11.2 Bending in two directions of load-bearing capacity

Distribution of the internal panel forces in the panel must be determined considering the biaxial load-bearing effect and one of the models described in Section 4.3.

Bending stresses

As shown in Figure 5-20, bending moments in sections longitudinal (x or 0° , resp.) and transverse to the top layer (y or 90° , resp.) result in stresses in different board layers. Therefore, verification of the bending stresses can be undertaken separately for both directions.

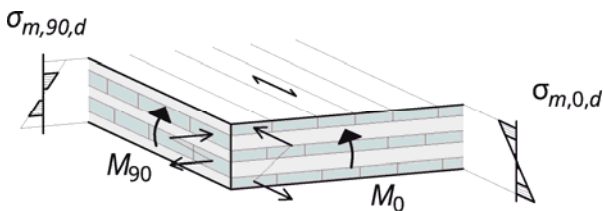

Figure 5-20: Independent stresses by bending about main and ancillary axes

Shearing stresses

Figure 5-21 shows shearing stresses for a panel element and for an enlarged board section. From the duality of the shearing stresses results the highest shearing stress by geometrical addition. With sufficient accuracy, verification in the two directions of load-bearing capacity can be undertaken separately.

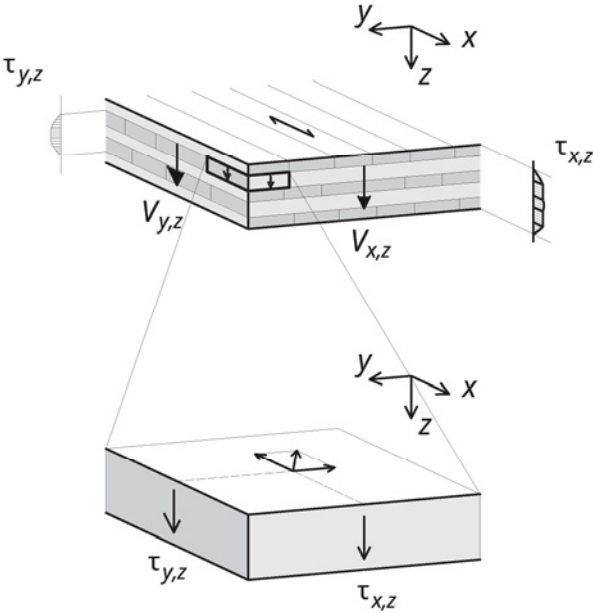

Figure 5-21: Shear stress in the two directions of load-bearing capacity

5.11.3 Oblique bending

If cross-laminated timber elements with an inclined longitudinal axis are used – as, for example, roof elements of pitched roofs – then, as a consequence of vertical load, the stress consists of one portion of panel bending (y) and one portion of upright bending (z). The basic stress curves are shown in Figure 5-22.

$$\sigma_{m,y,d} + \sigma_{m,z,d} \leq f_{m,d} \quad (5.37)$$

$$\frac{M_{y,d}}{W_{y,net}} + \frac{M_{z,d}}{W_{z,0,net}} \leq k_{mod} \cdot \frac{f_{m,k}}{\gamma_m}$$

With the cross-sectional values according to Sections 5.5 and 5.6.

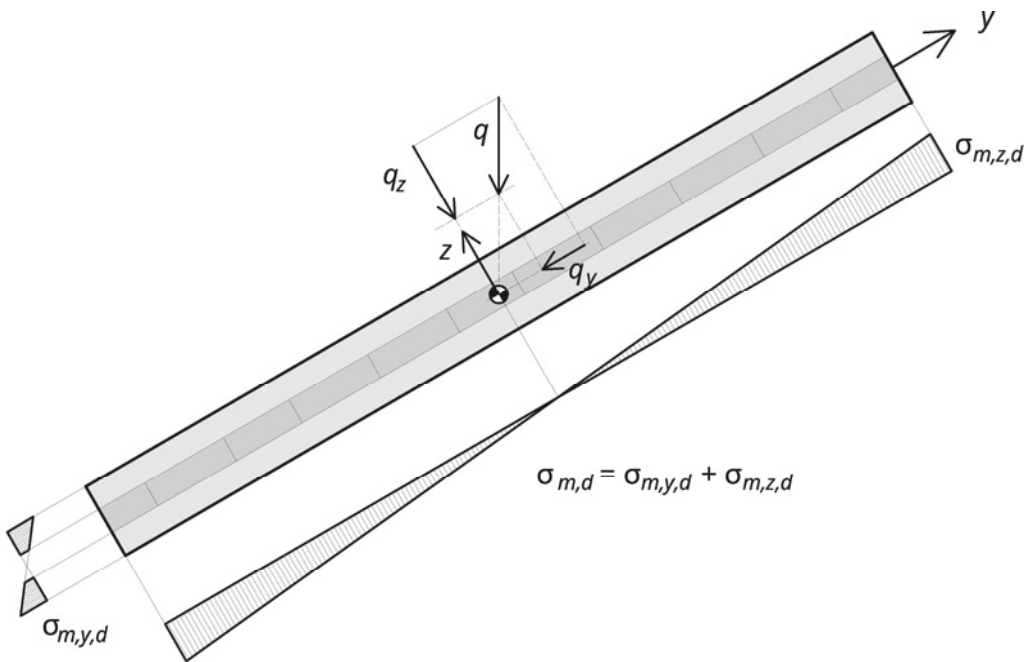

Figure 5-22: Oblique bending of a cross-laminated timber element arranged in an inclined fashion

5.12 Notches

For notches, structural design on the basis of Eurocode 5¹ is suggested. It has to be pointed out that in the national application document ÖNORM B 1995-1-1:2010, separate verifications are demanded for cross-laminated timber.

For unreinforced openings, it must be verified that

$$\tau_d = \frac{1,5 \cdot V_d}{b \cdot h_{ef}} \leq k_V \cdot f_{V,R,d} \quad (5.38)$$

with the coefficient of reduction for notched flexural members according to EN 1995-1-1

$$k_V = \frac{k_n}{\sqrt{h} \cdot \left(\sqrt{\alpha \cdot (1-\alpha)} + 0,8 \cdot \frac{x}{h} \cdot \sqrt{\frac{1-\alpha^2}{\alpha}} \right)} \quad (5.39)$$

$$\alpha = \frac{h_{ef}}{h} \dots\dots\dots \text{Coefficient of proportion}$$

For the material-dependent coefficient, $k_n = 4,50$ (for laminated veneer lumber) is suggested.

If the verification is not fulfilled, then reinforcements must be arranged, as, by way of example, shown in Figure 5-24. The course of the transverse tensile stresses is shown in Figure 5-23 for a five-layer element as an example. For cross-laminated timber, currently there are no more exact analyses on notches present, and more exact analyses are necessary – for example by means of the finite element method. The transverse tensile force to be absorbed lies between the full lateral force V_d and the transverse tensile force to be absorbed by the reinforcement in case of homogeneous, i.e. non-layered cross-sections, according to CEN (2012):

$$F_{t,0,d} = V_d \cdot 1,3 \cdot \left[3 \cdot (1-\alpha)^2 - 2 \cdot (1-\alpha)^3 \right] \leq V_d \quad (5.40)$$

$$\alpha = \frac{h_{ef}}{h} \dots\dots\dots \text{Coefficient of proportion}$$

h_{ef} Height of the residual cross-section above the support

h Overall height

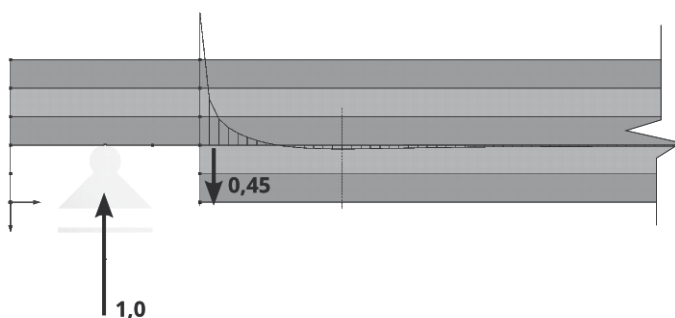
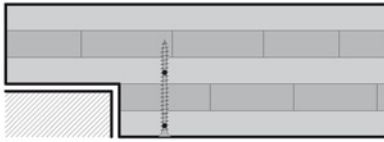

Figure 5-23: Basic curve of the transverse tensile stresses for notches

¹ EN 1995-1-1, Section 6.5.2.



Securing by means of fully threaded screw

Figure 5-24: Transverse tensile reinforcement of the notch

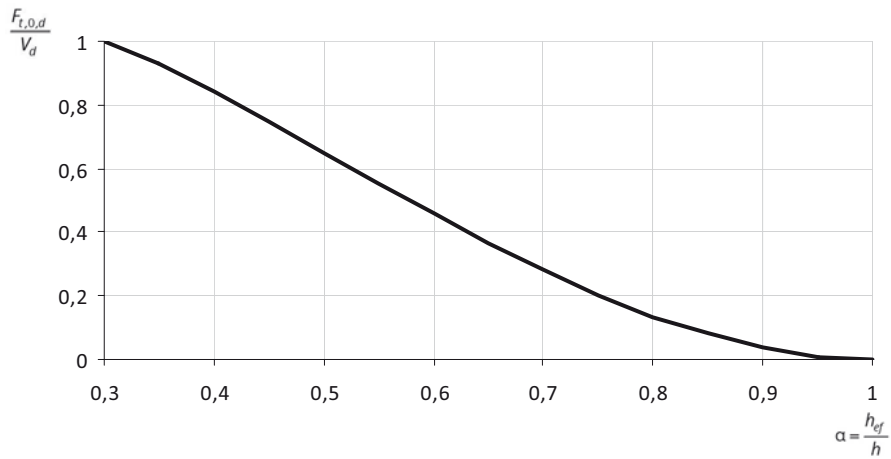

Figure 5-25: Relation between notch ratio and transverse tensile force

6 Serviceability limit states

6.1 Design situation

In timber construction, verifications of serviceability are undertaken in the characteristic and the quasi-permanent design situation.

The portions of deflection from the individual impacts must be superposed for the respective design situation according to EN 1995-1-1 and EN 1990. The portion of deformation from dead weight may be omitted for verifications in the characteristic design situation. For that, there are different interpretations of the Eurocodes and different national determinations. As a consequence, this results in differences in the overall deflections used for the verifications.

In the present guideline, as a conservative assumption, dead-weight deformation is always considered.

6.2 Limitation of deflections

With the limitation of vertical deflections, two aims are pursued. On the one hand, the appearance is to be maintained, and on the other hand, damages to subordinate structural elements or limitations of use by deformations are to be avoided.

In Eurocode EN 1995-1-1, the permitted deflection ranges are limited. Within these ranges, limit deflections are determined in the national application documents. For every project, serviceability criteria should be determined according to the requirements for utilisation and agreed with the builder owner.¹

End deflection

End deflection results from initial deformation w_{inst} plus creep deformation w_{creep} . For creep deformation, the deformations from the quasi-permanent portions ($\psi_{2,i}$) are multiplied with the coefficient of deformation k_{def} depending on the utilisation class and the building material according to Section 3.5.

¹ EN 1990:2003, Section A.1.4.2., Paragraph (2).

6.2.1 Combination and limits for deflections

Maintenance of the appearance in the quasi-permanent design situation

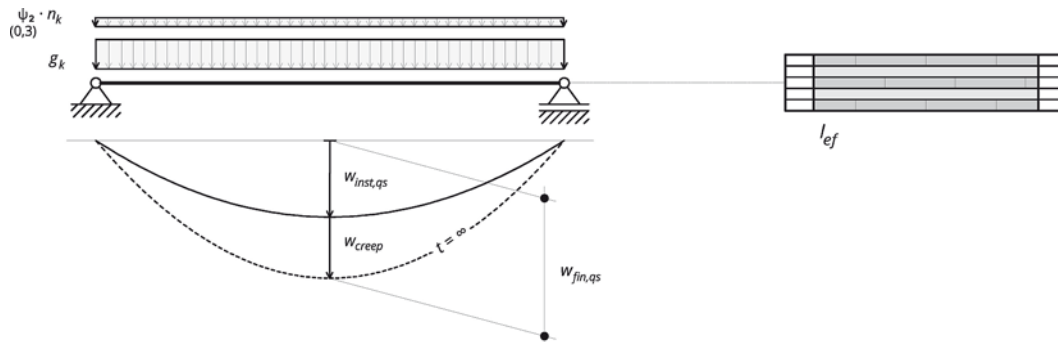

Figure 6-1: Quasi-permanent design situation

$$w_{fin,qs} = w_{inst,qs} \cdot (1 + k_{def}) \leq \frac{l}{250}$$

$$w_{inst,qs} = W_G^{\oplus} \sum_{i \geq 1} \psi_{2,i} \cdot W_{Q,i}$$

$$w_{creep} = k_{def} \cdot w_{inst,qs}$$

$w_{inst,qs}$ Initial deformation in the quasi-permanent design situation

w_{creep} Creep portion (always from the quasi-permanent design situation)

$w_{fin,qs}$ End deformation in the quasi-permanent design situation

k_{def} Coefficient of deformation (acc. to Section 3.5)

Avoidance of damages and limitations of utilisation in the characteristic design situation

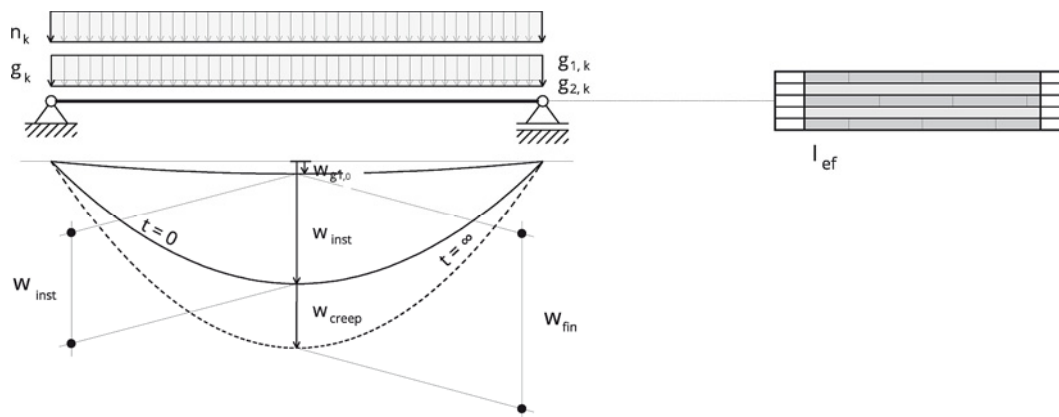

Figure 6-2: Characteristic design situation

Initial deformation:

$$w_{inst} = (w_{g,1} + w_{g,2}) \oplus w_{q,1} \oplus \sum_{i>1} \psi_{0,i} \cdot w_{q,i} \leq \frac{l}{300}$$

End deformation:

$$w_{fin} = w_{inst} + w_{creep} \leq \frac{l}{200}$$

- w_{inst} Initial deformation in the characteristic design situation
- w_{fin} End deformation in the characteristic design situation
- w_{creep} Creep portion (always from the quasi-permanent design situation)

The portion of permanent loads may be reduced by that part of the permanent loads $w_{g,1}$, which is effective with subordinate structural elements at the time of finishing. Verification of the end deformation w_{fin} with the deflection limits stated normally is not decisive; the measure of deflection, however, is required for dimensioning of possible compensation structures.

6.3 Vibrations

6.3.1 General

According to EN 1995-1-1:2009, Section 7.3, for structures, in general, it must be “ensured that impacts to be frequently expected do not cause vibrations affecting the function of the building or causing the users unpleasant discomfort”. For apartment ceilings, verifications of vibration are demanded.

The vibration performance can be assessed by measurements or estimated by calculations. In that, the most important physical quantities are the first natural frequency, the stiffness and the damping behaviour of the ceiling.

In order to avoid resonance, a sufficient distance between excitation frequency and first natural frequency is being aimed at. Excitation by steps takes place about two times per second, i.e. with 2,00 Hz. Upon walking, there furthermore is excitation with twice the frequency of about 4,00 Hz. In Eurocode 5, for sufficient distance to the excitation frequency, a first natural frequency of at least 8,00 Hz is now required.

The behaviour of ceilings susceptible to vibration can be improved by additional supports (span reduction) or by reinforcement measures (higher stiffness). Load distribution transverse to the direction of span and higher damping have beneficial effects.

If the required minimum frequency cannot be complied with, verification of vibration is possible via limitation of the vibration acceleration.

6.3.2 Basic principles

Natural frequency and damping

If a structural element is deflected and released, it vibrates around its rest position until it gradually returns to the same.

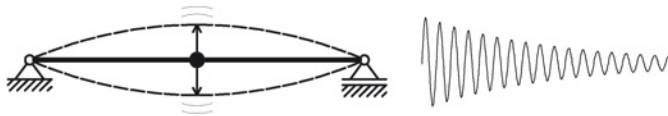

Figure 6-3: Vibration performance of a structural element

The frequency f is the number of vibrations per second. Damping can be stated from the relation of two consecutive amplitudes as Lehr's damping ratio or also as the logarithmic decrement D .

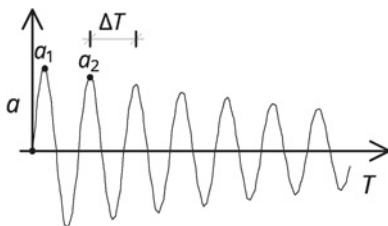

Figure 6-4: Vibration frequency of a structural element

$$f_1 = \frac{1}{\Delta T} \tag{6.1}$$

$$D = \ln\left(\frac{a_1}{a_2}\right) \tag{6.2}$$

Single-span beam with uniformly distributed mass

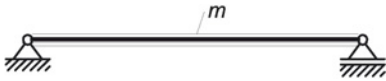

Figure 6-5: Uniform force impact on single-span girder

The first natural frequency of a single-span girder uniformly loaded with mass can be determined independent of damping as follows¹:

$$f_{1,beam} = \frac{\pi}{2 \cdot \ell^2} \cdot \sqrt{\frac{E \cdot I_0}{m}} \tag{6.3}$$

ℓ Span of the single-span girder [m]

m Distributed mass [kg/m]

$E \cdot I_0$ Flexural stiffness [Nm²]

Single-degree of freedom system, generalised mass

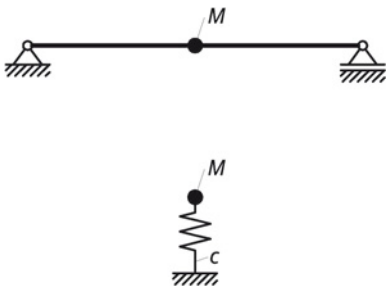

Figure 6-6: Generalised mass

For determination of the first natural frequency, vibrating systems like apartment ceilings may be reduced to a single-degree of freedom system.

The natural frequency of a single-degree of freedom system is

$$f_1 = \frac{1}{2 \cdot \pi} \cdot \sqrt{\frac{c}{M}} \tag{6.4}$$

M Modal mass [kg]

c Spring rigidity [N/m]

For a single-span girder, the spring rigidity against vertical deformation in the centre of the girder results as follows

$$c = \frac{48 \cdot E \cdot I_{ef}}{\ell^3} \tag{6.5}$$

¹ See Müller (1978).

The modal mass is:

$$M \approx \frac{8}{15} \cdot m \cdot \ell \tag{6.6}$$

Using these values, equation (6.4) can be converted to equation (6.3) with good approximation.

Influence of the transverse load-bearing effect

Analyses and comparative calculations show that biaxial load distribution and partial restraint of floors have a beneficial effect on the natural frequency. These effects can only be mapped with suitable modelling (for example as grillage or orthotropic panel).

For manual calculation, for rectangular apartment ceilings supported on all sides, the influence of flexural stiffness transverse to the main direction of span $E \cdot I_{transverse}$ can be derived from a grillage model and considered. The improvement only becomes effective from a ratio of flexural stiffnesses in the ancillary direction of load-bearing capacity to the main direction of load-bearing capacity of $\frac{E \cdot I_{transverse}}{E \cdot I_0} > 0,05$.

$$f_1 = \frac{\pi}{2 \cdot \ell^2} \cdot \sqrt{\frac{E \cdot I_0}{m}} \cdot k_{transverse} \cdot k_e \tag{6.7}$$

$$k_{transverse} = \sqrt{1 + \left[\left(\frac{\ell}{b} \right)^2 + \left(\frac{\ell}{b} \right)^4 \right] \cdot \frac{E \cdot I_{transverse}}{E \cdot I_0}} \tag{6.8}$$

- b Width of ceiling span transverse to the main direction of load-bearing capacity [m]
- $E \cdot I_{transverse}$ Stiffness transverse to the direction of span
- $k_{transverse}$ Influence of the transverse load-bearing effect according to Augustin (2012)
- k_e Influence of the static system according to the following section

Influence of the static system

The influence of the static system can be considered in an approximate fashion via or for double-span girders. Partial restraints at the ceiling edges have a beneficial effect on the first natural frequency.

Table 6-1 Factors for determination of the natural frequency of differently supported single-span girders

Coefficients for consideration of different types of support	$k_{e,1}$
Articulates – articulated	1,000
Restrained – articulated	1,562
Restrained – restrained	2,268
Restrained – free (cantilever beam)	0,356

Table 6-2 Factors for determination of the natural frequency of double-span girders depending on relation of the spans

ℓ_2 / ℓ_1	1,0	0,9	0,8	0,7	0,6	0,5	0,4	0,3	0,2	0,1	0
$k_{e,2}$	1,000	1,090	1,157	1,206	1,245	1,282	1,318	1,359	1,410	1,474	1,562

Relation between natural frequency and deflection

From the comparison of the natural frequency of a single-span girder according to equation (6.7) with the deflection in the centre of the span $w_m = \frac{5 \cdot m \cdot \ell^4}{384 \cdot E \cdot I_0}$, the following relation can be formed:

$$f_1 \approx \frac{18}{\sqrt{w_m}} \quad (6.9)$$

w_m Deflection as a consequence of the uniform mass allocation m in [mm]

Systems of structural elements susceptible to vibration arranged on top of one another

If a vibrating system consists of several structural elements, as, for example, ceilings with joists, then the first natural frequency can be determined from n elements according to the approximation formula of Dunkerley¹.

$$\frac{1}{f^2} \approx \frac{1}{f_{1,a}^2} + \frac{1}{f_{1,b}^2} + \dots + \frac{1}{f_{1,n}^2} \longrightarrow f = \sqrt{\frac{1}{\frac{1}{f_{1,a}^2} + \frac{1}{f_{1,b}^2} + \dots + \frac{1}{f_{1,n}^2}}} \quad (6.10)$$

Example: Compliance with a limit frequency of 6,00 Hz for a ceiling (De) with joist (Uz).

$$f_{1,De} = 8,50 \text{ Hz}$$

$$f_{1,Uz} = 8,50 \text{ Hz}$$

$$f = \sqrt{\frac{1}{\frac{1}{f_{1,De}^2} + \frac{1}{f_{1,Uz}^2}}} = \sqrt{\frac{1}{\frac{1}{8,50^2} + \frac{1}{8,50^2}}} = 6,0 \text{ Hz}$$

Recalculated for deflections, this means that the sum of the individual deflections must be limited:

$$w_1 + w_2 + w_3 + \dots \leq w_{\text{grenz}} \quad (6.11)$$

Modal mass

That part of the mass on an element, which is activated with a certain mode of vibration, can be understood as the modal or also generalised mass.

For that, for a known mode of vibration, the mass effective in each node is multiplied with the square of the node displacement. The natural mode must be previously standardised to the maximum value of 1,0.

$$M = \sum_{i \geq 1} w_{i,natural}^2 \cdot M_i \quad (6.12)$$

i Number of nodes

¹ Hivoss (2008).

The ratio between actual and modal mass can be stated as a factor. The modal mass then is

$$M^* = k_{M^*} \cdot M \tag{6.13}$$

For single-span girders, the modal mass has already been stated in formula (6.), it is determined in an approximate fashion with

$$k_{M^*} \approx \frac{8}{15}, k_{M^*} \approx 0,5 \text{ resp.} \tag{6.14}$$

For continuous girders, the modal mass increases, since the neighbouring span vibrates as well. The modal mass of a continuous girder across two spans with the same length is twice as high as that of a single-span girder across one of the two spans.

Table 6-3 Factors for determination of the modal mass of double-span girders depending on the relation of the spans¹

ℓ_2/ℓ_1	1,0	0,9	0,8	0,7	0,6	0,5	0,4	0,3
k_{M^*}	1,00	0,70	0,575	0,525	0,5	0,485	0,475	0,467

For panels supported in an articulated fashion on all sides, mathematical sequence approaches can be used for the natural vibration modes in order to facilitate determination of the modal mass.

From a grillage consideration, the following relation can be formed via the coefficient for the transverse load-bearing effect:

$$k_{M^*} = \frac{1}{2 \cdot k_{quer}^2} \geq 0,25 \tag{6.15}$$

$$k_{transverse} = \sqrt{1 + \left[\left(\frac{\ell}{b} \right)^2 + \left(\frac{\ell}{b} \right)^4 \right] \cdot \frac{E \cdot I_{transverse}}{E \cdot I_0}} \tag{6.16}$$

$k_{transverse}$ Influence of the transverse load-bearing effect

From Hivoss (2008), the following factor can be determined for individual rectangular spans supported on all sides:

$$k_{M^*} = \frac{1}{2} - \frac{\ell}{4 \cdot b} \tag{6.17}$$

The modal mass for a square ceiling span supported on all sides with the same stiffness in both directions results as the lower limit for the modal mass of a panel in

$$k_{M^*} \approx 0,25 \tag{6.18}$$

For cross-laminated timber, the factor mostly lies between 0,30 and 0,40.

¹ According to Blaß, Ehlbeck, Kreuzinger und Steck (2005), p. 90.

6.3.3 Verifications of vibration

Limitation of the vibration performance by means of calculation with respective verifications is difficult, not least due to the subjective perception of the users. In the following, the verification of vibration according to Hamm und Richter (2009) with extensions by Augustin (2012) is described.

Vibration classes with requirements to frequency and stiffness (Hamm and Richter)

According to Table 6-4, ceilings are classified into three classes with respect to their vibration performance.

For verification, two criteria in terms of

- the first natural frequency, and
- the stiffness of the ceiling (deflection as a consequence of a unit load)

must be fulfilled.

If the first natural frequency is below the limit value, then, according to Hamm and Richter, for heavy ceilings, the utilisation comfort can be maintained by compliance with a limit acceleration, as shown in Figure 6-7.

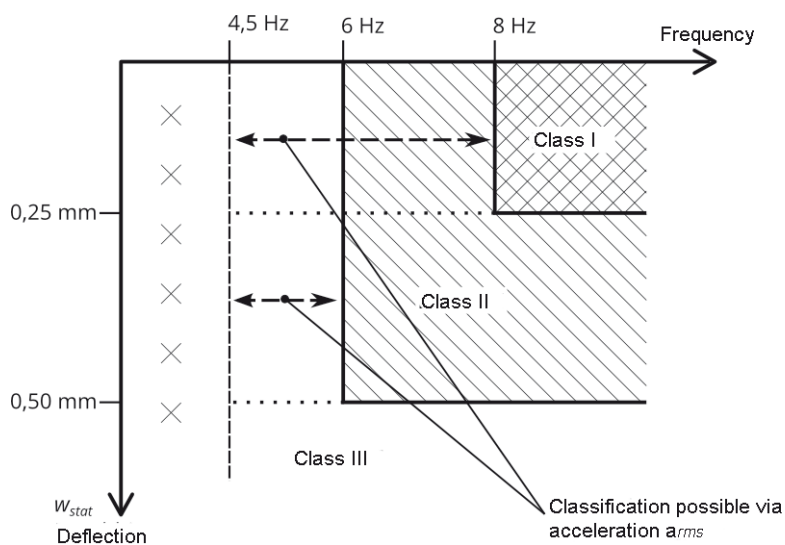

Figure 6-7: Classification with respect to the vibration performance

w_{1kN} Deflection in [mm] as a consequence of a unit force of 1 kN at the most unfavourable point

f_1 First natural frequency [Hz]

a_{rms} Effective value of the vibration acceleration [m/s^2]

Table 6-4 Vibration classes of ceilings

	Vibration class I	Vibration class II	Vibration class III
Typical applications	Ceilings between different utilisation units, like separating ceilings between apartments, continuous ceilings, ceilings in offices, etc.	Ceilings within one utilisation unit, ceilings in single-family houses with common utilisation	Ceilings under undeveloped attics, ceilings without vibration requirement
Execution	Wet screed floating on light or heavy fills Dry screed on heavy fill (i.e. with more than 60 kg/m ²)	Wet screed floating (also without fill)	-
Frequency criterion	$f_1 \geq 8 \text{ Hz}$	$f_1 \geq 6 \text{ Hz}$	
Stiffness criterion¹	$w_{1kN} \leq 0,25 \text{ mm}$	$w_{1kN} \leq 0,50 \text{ mm}$ for low requirements: $w_{1kN} \leq 1,00 \text{ mm}$	
Limit acceleration²			
Hamm und Richter (2009) or Kreuzinger und Mohr (1999) upon transfer of vibration into the adjacent room, resp.	$a_{rms} \leq 0,05 \text{ m/s}^2$ additionally $f_1 \geq 4,5 \text{ Hz}$	$a_{rms} \leq 0,10 \text{ m/s}^2$ $f_1 \geq 4,5 \text{ Hz}$	

¹ Limit values according to Hamm und Richter (2009). Rabold and Hamm (2009) describe the higher limit value for lower requirements. Kreuzinger und Mohr (1999) suggest about twice the limit values.

² "For structural design [...], the following limit values are suggested for abating vibrations with timber beam ceilings in residential buildings. In the range from 4 to 8 Hz, a vibration acceleration of 0,40 m/s² is decisive as the limit; [...] If transfer of the pulses into another room is possible, then the values for this room should be reduced to 0,10 m/s² [...]." Kreuzinger und Mohr (1999), Section 4.3, p. 36.

Frequency criterion

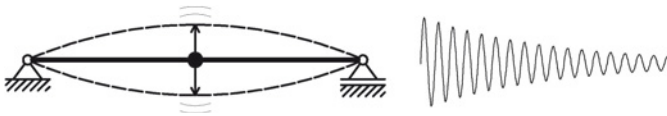

Figure 6-8: Vibration of a structural element

The first natural frequency can be determined according to the formulas in Section 6.3.2. For the vibrating mass m , the permanent loads alone are applied

$$m = g_{1,k} + g_{2,k} \tag{6.19}$$

Table 6-3 states the deflection limit corresponding to the respective natural frequency as a consequence of permanent loads.

Table 6-3 Deflection limits associated with the first natural frequency

	Vibration class I	Vibration class II	Lowest limit frequency for verification of vibration acceleration
Frequency criterion	$f_1 \geq 8 \text{ Hz}$	$f_1 \geq 6 \text{ Hz}$	$f_1 \geq 4,50 \text{ Hz}$
Respective deflection as a consequence of $g = g_{1,k} + g_{2,k}$	$w_m \leq 5 \text{ mm}$	$w_m \leq 9 \text{ mm}$	$w_m \leq 16 \text{ mm}$

Stiffness criterion

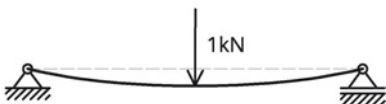

Figure 6-9: Deflection of a single-span girder as a consequence of a point load

The deflection as a consequence of a point load $F = 1\text{kN}$ at the most unfavourable point for a single-span girder without transverse distribution is

$$w_{stat} = \frac{1 \text{ kN} \cdot \ell^3}{48 \cdot E \cdot I_{ef}} \cdot 1.000 \leq w_{grenz} \tag{6.20}$$

ℓ Span of the single-span girder [m]

$E \cdot I_{ef}$ Effective flexural stiffness [kNm²]

The transverse distribution may be applied as follows:

$$w'_{1kN} = \frac{1 \text{ kN} \cdot \ell^3}{48 \cdot E \cdot I_{ef0}} \cdot \frac{1}{b_F} \cdot 1.000 \leq w_{grenz} \tag{6.21}$$

$$b_F = \min \left\{ \frac{\ell}{1,1} \cdot 4 \sqrt{\frac{EI_{transverse}}{E \cdot I_0}}; b \right\} \geq 1 \tag{6.22}$$

ℓ Span [m]

b Width of the ceiling span transverse to the main direction of load-bearing capacity [m]

b_F Co-effective width of the ceiling span [m]

$E \cdot I_{0,ef}$ Flexural stiffness in the direction of span [kNm²]

$E \cdot I_{transverse}$ Flexural stiffness transverse to the direction of span [kNm²]

Low stiffness portions in the transverse direction already result in a strong improvement. With a ratio of $\frac{EI_{transverse}}{E \cdot I_{0,ef}} = \frac{3}{100}$, the result already is $b_F = 0,38 \cdot \ell$.

Limit acceleration

If the required minimum frequency according to Table 6- cannot be exceeded, then, for heavy ceilings, the utilisation comfort can be maintained by compliance with a limit acceleration, if a minimum frequency of 4,50 Hz is complied with. The respective verification scheme is shown in Figure 6-10.

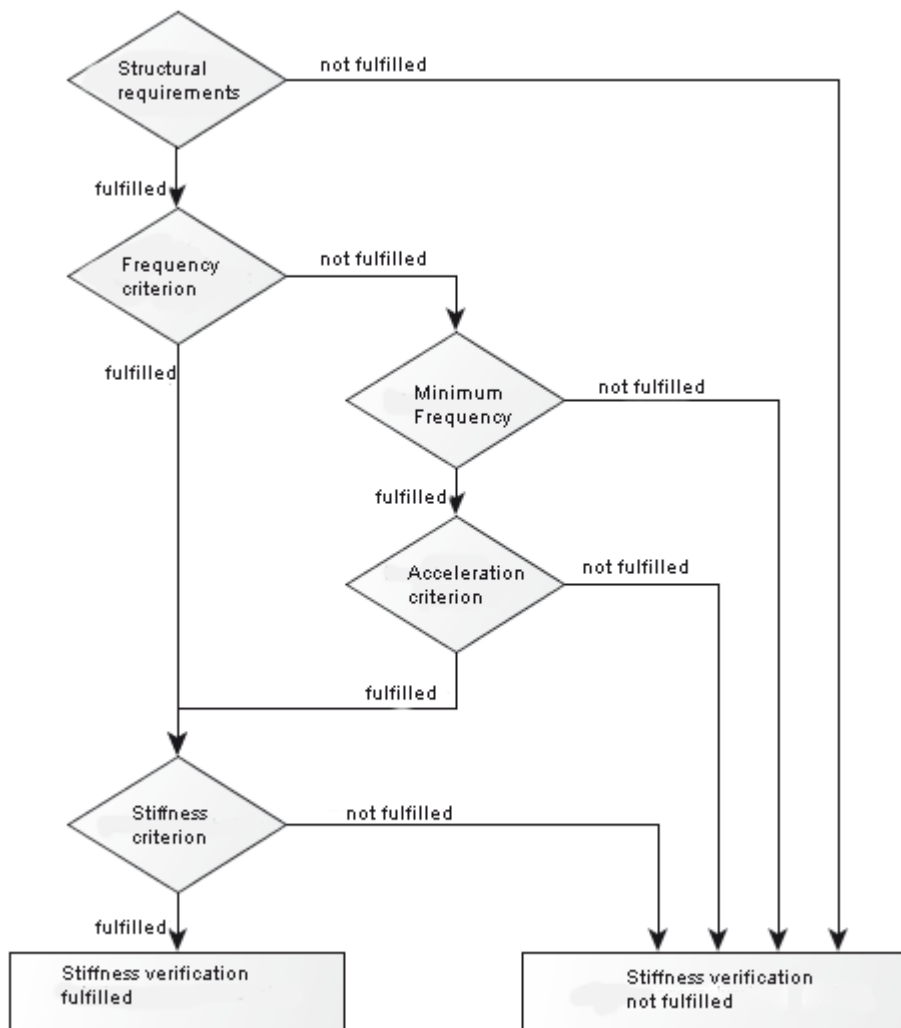

Figure 6-10: Flow diagram for verification of vibration

Acceleration occurs as a response of the ceiling to a person walking thereon.

$$a_{rms} = \frac{0,4 \cdot \alpha \cdot F_0}{M \cdot 2 \cdot D} = \frac{280 \cdot \alpha}{M \cdot 2 \cdot D} \leq a_{grenz} \quad (6.23)$$

F_0 Weight force of a walking person $F_0 = 700 [N]$

M^* Modal mass according to Section 6.3.2 in [kg]

D Modal degree of damping (also Lehr's damping ratio) in [-]
according to Table 6-6

$\alpha = e^{-0,47 \cdot f_1}$ Coefficient for consideration of the influence of the natural frequency on vibration acceleration in [-]

$$\alpha = e^{-0,47 \cdot f_1}$$

The dependency from the first natural frequency is shown in Figure 6-11.

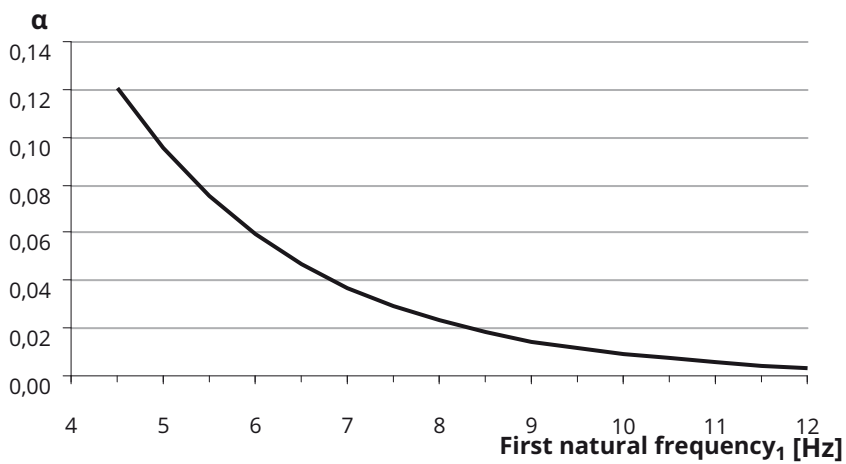

Figure 6-11: Dependency of the coefficient α on the first natural frequency

The amount of acceleration depends on the distance of the natural frequency to the excitation frequency and assumes the highest values in the case of resonance¹. Acceleration can be improved by increasing the ceiling stiffness, and consequently the first natural frequency, and by increasing the co-vibrating mass.

Vibration acceleration is used as an evaluation quantity in other verification methods, too (see 6.3.4. One-step root mean square). The calculation models and limit values for acceleration are currently being discussed.

Table 6-6 Degrees of damping for various ceiling structures²

Type of ceiling structure	Modal degree of damping D
Ceiling structures without or with light floor structure, resp.	0,01
Ceiling structures with floating screed	0,02
Cross-laminated timber ceilings without or with light floor structure, respectively	0,025
Timber beam ceilings and mechanically connected board-stack ceilings with floating screed	0,03
Cross-laminated timber ceilings with floating screed and heavy floor structure	0,035

6.3.4 Alternative verifications of vibration

Verification according to Eurocode 5 (EN 1995-1-1:2009)

For the verification of vibration, criteria for natural frequency, vibration velocity and stiffness are defined in EN 1995-1-1. Mostly compliance with the first natural frequency is decisive.

$$f_1 \leq f_{\text{grenz}} = 8 \text{ Hz} \quad (6.24)$$

For natural frequencies below 8,00 Hz, special analyses are required. Furthermore, stiffness of the ceiling as a consequence of point load and pulse velocity must be limited. For frequency ranges between 4,50 and 8,00 Hz, limitation of the vibration acceleration without a verification defined in more detail is suggested in the Austrian application document.

¹ According to Hamm und Richter (2009), $\alpha = 0,1$ is determined for the limit case of resonance. This provides the value of the stated compensation function $\alpha = e^{-0,47 \cdot f_1}$ for $f_1 = 5 \text{ Hz}$. In Kreuzinger und Mohr (1999), acceleration is stated considering the natural frequency of the ceiling. Accordingly, in the range from 6,9 to 8 Hz, the

term $2 \cdot D$ may be replaced by the term $\sqrt{\left(1 - \frac{f_F^2}{f_1^2}\right)^2 + \left(2 \cdot D \cdot \frac{f_F}{f_1}\right)^2}$ with $f_F = 6,9 \text{ Hz}$.

² According to Augustin (2012).

Limitation of absolute deflection (DIN 1052:2010)

As described above, limitation of the natural frequency is equivalent to an absolute limitation of deflection. In DIN 1052:2010, Section 9.3, respectively there is the verification for dead weight and quasi-permanent portion of the live loads:

$$w_{inst,q_s} \leq w_{grenz} = 6 \text{ mm} \quad (6.25)$$

$$w_{inst,q_s} = w_{g,k} + \psi_2 \cdot w_{n,k} = w_{g,k} + 0,3 \cdot w_{n,k} \quad (6.26)$$

There is the following relation between this deflection requirement and the frequency requirement:

$$w_{grenz} \geq 6 \text{ mm} \Leftrightarrow f_{1,q_s} \geq 7,35 \text{ Hz} \quad (6.27)$$

In the literature, it is pointed out that fulfilment of the first natural frequency alone cannot be considered sufficient.

One-step root mean square (OS-RMS)

As an addition to the verification method for timber construction described above, here, a general verification method is to be mentioned, which was prepared within the scope of the Hivoss programme¹ and can be used as an alternative verification method from case to case.

The *one-step root mean square* (OS-RMS) method was published as Report EUR 21972 EN (2006). The OS-RMS value indicates the vibration response in the form of acceleration of a ceiling, which is initiated by a person walking thereon.

The vibration responses were evaluated for various degrees of damping, masses and frequencies in the form of diagrams. With the input values damping, modal mass and first natural frequency, ceilings can be classified with respect to their vibration properties, as basically shown in Figure 6-12.

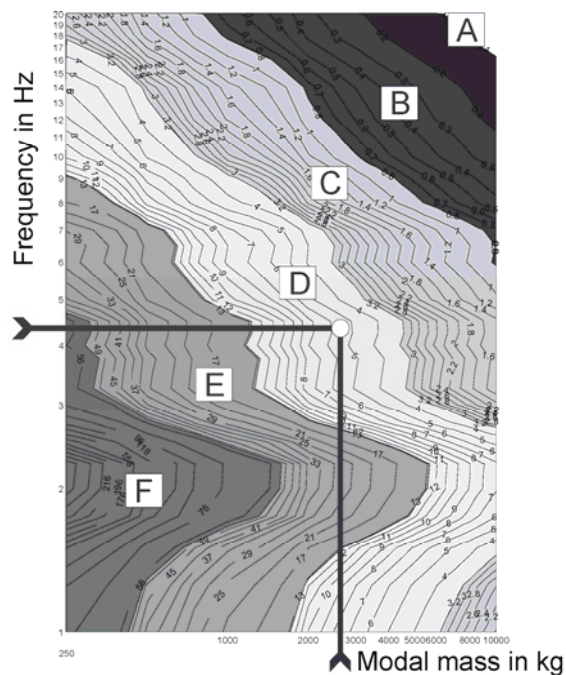

Figure 6-12: Basic approach for vibration classification of ceilings

¹ See Hivoss (2008)

7 Ultimate limit states in the event of fire

7.1 Design situation

The verifications of load-bearing capacity in the event of fire must be undertaken in the extraordinary design situation. Generally – depending on national determinations – the leading variable impact may be combined with its quasi-permanent portion ψ_2 .

$$E_{fi,d} = \sum G_{k,j} \oplus \sum_{i \geq 1} \psi_{2,i} \cdot Q_{k,i} \quad (7.1)$$

For roof structures, it is recommended to use the frequent portion ψ_1 of the leading variable impact, since for loads on roofs frequently $\psi_2 = 0$.

$$E_{fi,d} = \sum G_{k,j} \oplus \psi_{1,1} \cdot Q_{k,1} \oplus \sum_{i > 1} \psi_{2,i} \cdot Q_{k,i} \quad (7.2)$$

According to EN 1991-1-1, Paragraph 6.2.1 (3), “a local minimum load-bearing capacity of ceilings must be ensured”. For that, “a separate verification with a point load must be undertaken, which, unless regulated otherwise, does not have to be combined with the uniformly distributed load and other variable impacts”. For apartment ceilings, this means a man load of $Q_k = 1,50$ kN, which, from the authors’ point of view, must be considered for the fire verification without coefficient ψ .

According to EN 1991-1-1, Paragraph 6.4 (1), for fall protection, an additional horizontal load at a height of 1,20 m must be considered. From the authors’ point of view, a horizontal load of about $q_k = 1,00$ kN/m without coefficient ψ should be applied for walls in the event of fire, too.

7.2 Charring and cross-sectional values

In the ultimate limit states in the event of fire, following the required fire resistance time, the element reduced by charring is analysed in the extraordinary design situation. First, the charring depth $d_{char,n}$ for the required fire resistance time is determined. In order to consider the temperature distribution in the remaining cross-section, according to EN 1995-1-2, either a) the method with a reduced cross-section or b) the method with reduced material properties can be applied (see Figure 7-1). Currently, the standard details on reduced material properties are restricted to rod-shaped elements; therefore, the reduced cross-section method is applied for cross-laminated timber. For this reduced cross-section, a layer thickness $k_0 d_0$ without strength and stiffness is deducted from the charred cross-section.

$$d_{ef} = d_{char,n} + k_0 d_0 \quad (7.3)$$

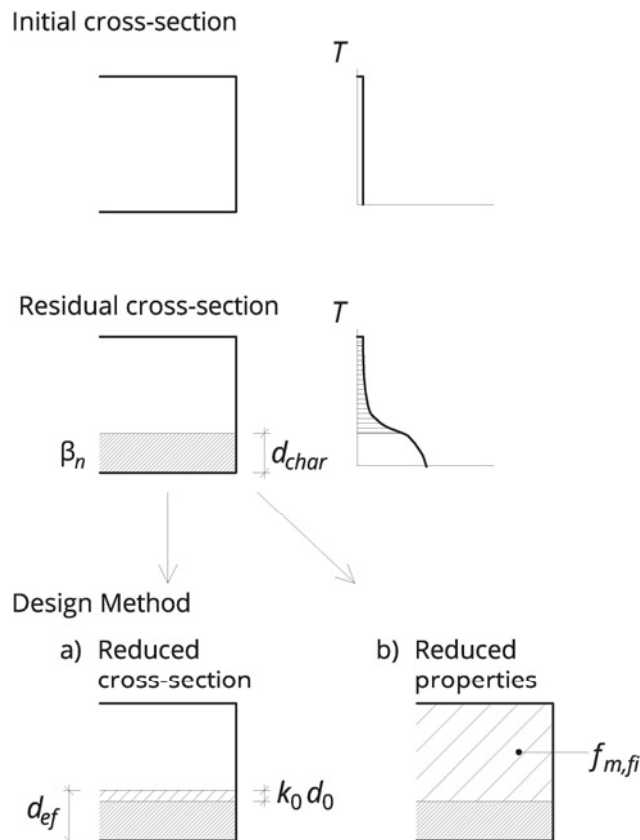

Figure 7-1: Charring and calculation methods

Charring depth

Newer fire tests show that an increased temperature results in reduced adhesive properties of thermoplastic adhesives like polyurethane. Therefore, with this type of adhesive, detachment of partial areas of the charred layers may occur in ceilings and other horizontally installed elements, which is called delamination. In descriptions, these areas are described as about palm-sized.

For failing fire-protection layers, a calculation model exists in EN 1995-1-2:2006. This was applied to cross-laminated timber. In that, it was assumed that following complete failure of a fire-protection layer – for example suspended plasterboards falling down – first, charring occurs at twice the speed. After 25 mm of charring, the normal charring rate can be assumed again, since a new protective layer could be formed by charring. Figure 7-2 shows the effects of this model on a five-layer element as an example. The dashed line corresponds to uniform charring.

Fire tests with small and larger samples¹ show lower charring rates compared to this model, and it depends on the choice of the suitable design method to represent charring realistically, but not too conservatively.

At the time of publication, there is no universally valid structural design method. In practical structural design, depending on the fire expertise, different charring rates are used, mostly without application of delamination.

¹ Teibinger und Matzinger (2010).

Method of reduced cross-sections

The increased temperature exceeding the calculated charring limit $d_{char,n}$ results in a reduction of the material properties. This is considered via a layer without strength $k_0 d_0 = 7 \text{ mm}$.

Comparative calculations show that the value of $k_0 d_0 = 7 \text{ mm}$ does not generally apply to all cross-laminated timber build-ups and stresses. Depending on the position of the transverse layers, jumps exceeding 7 mm may occur, as described in Schmid et al. (2010). With a risk of buckling, comparative calculations likewise result in higher values.

Method of reduced material properties

Due to the layered build-up of cross-laminated timber, from today's point of view, an alternative fire verification using reduced material properties is reasonable. For that, fire tests already performed could be assessed and reduction factors $k_{mod,fi}$ for cross-laminated timber calculated.

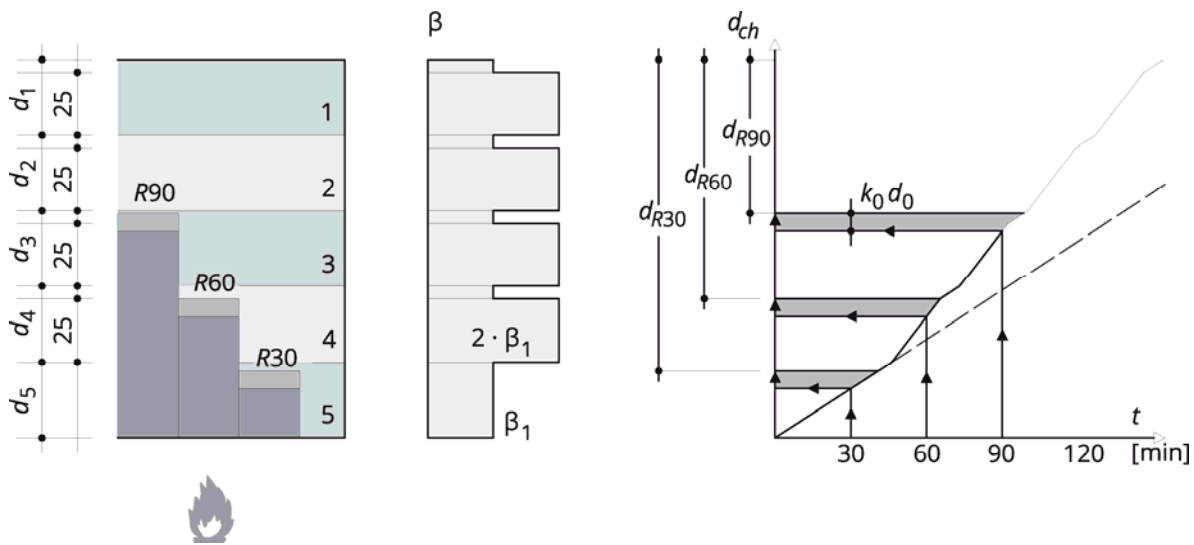

Figure 7-2: Cross-section, charring depth and time curve of charring for a ceiling element considering delamination

WALL single-sided

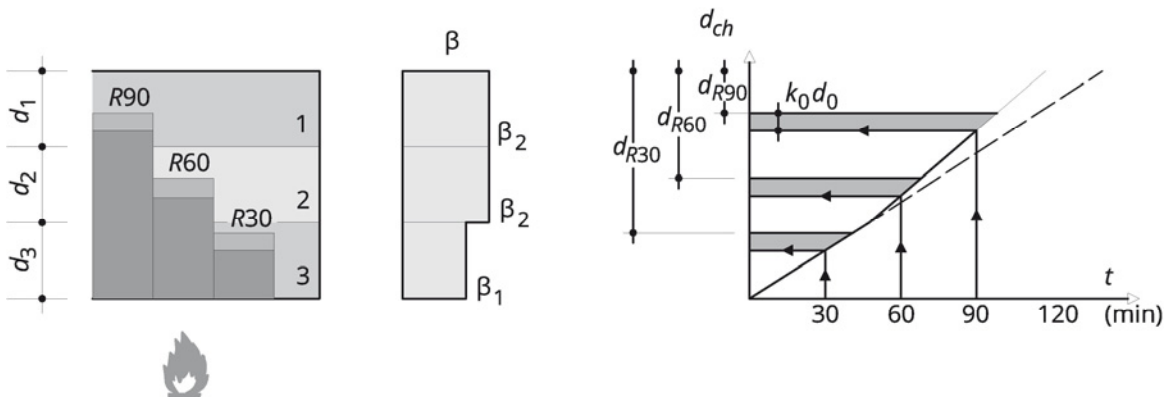

Figure 7-3: Cross-section, charring rate and time curve for unilateral charring of a wall element

WALL double-sided

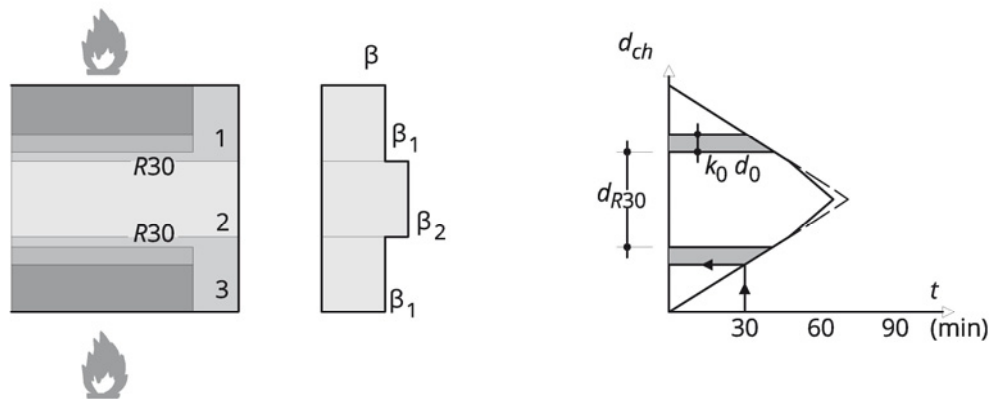

Figure 7-4: Cross-section, charring rate and time curve for bilateral charring of a wall element

Cross-laminated timber girder

For the upright use as a girder, according to the determinations for rectangular cross-sections, increased charring β_n must be assumed in order to consider corner rounding caused by charring.

Charring rates with heat-proof adhesion

Upon using cross-laminated timber in the area, one-dimensional charring may be used for calculation.

$$\beta_n = \beta_0 = 0,65 \text{ mm/min}$$

Charring rates with non-heat-proof adhesion

Since currently the determination of the charred residual cross-section is regulated differently depending on the manufacturer, in the following, a selection of established models and charring rates is described.

Source		Cross-laminated timber guideline ¹	HFA opinion ²
Ceiling	First layer	$\beta_1 = 0,65 \text{ mm/min}$	
	From the second layer on	$\beta_2 = 2 \cdot 0,65 \text{ mm/min}$	
	per layer	$\beta_1 = 0,65 \text{ mm/min}$	
	For the first 25 mm For the rest of the layer	$k_0 \cdot d_0$	$k_0 d_0 = 7 \text{ mm}$
Wall	First layer	$\beta_1 = 0,65 \text{ mm/min}$	
	From the second layer on	$\beta_1 = 0,65 \text{ mm/min}$	$\beta_1' = 0,86 \text{ mm/min}$
	$k_0 \cdot d_0$	$k_0 d_0 = 7 \text{ mm}$	

Residual laminates

Residual laminates with a thickness of no more than 3 mm remaining following charring are omitted. Comparative calculations show, that for the majority of the cases, the cross-section following failure of these residual laminates has a higher resistance than with the laminates.

¹ See Schickhofer et al. (2010), Chapter 5. The values apply to cross-laminated timber elements without joints. With joints up to a thickness of 4 mm, $\beta_0 = 0,8 \text{ mm/min}$ is applied.

² Expert opinion No. 122/2011/02-BB, Vienna: Holzforschung Austria, 2011.

7.3 Verification

In the event of fire, verification may be undertaken without safety factors and with higher strengths (20 % fractile).

At stress level, the verification is as follows:

$$\sigma_{f_i,d} \leq f_{f_i,d}$$

$$\sigma_{f_i,d} \leq k_{\text{mod},f_i} \cdot \frac{f_{20}}{Y_{M,f_i}}$$

$$\sigma_{f_i,d} \leq k_{f_i} \cdot k_{\text{mod},f_i} \cdot \frac{f_k}{Y_{M,f_i}} = 1,15 \cdot f_k$$

k_{mod,f_i} Coefficient of modification in the event of fire

For the reduced cross-section method, $k_{\text{mod},f_i} = 1,00$ ¹

f_{20} 20 % fractile of strength at normal temperature

$$f_{20} = k_{f_i} \cdot f_k$$

k_{f_i} Coefficient for conversion from 5 % to 20 % fractiles. For cross-laminated timber, $k_{f_i} = 1,15$ is normally used².

f_k 5 % fractile of strength (acc. to EN 1995-1-1)

Y_{M,f_i} Partial safety factor for timber in the event of fire

$$Y_{M,f_i} = 1,0$$

7.3.1 Strengths in the event of fire

Table 7-1 Characteristic strength values for cross-laminated timber upon use as a panel in the event of fire

		Suggested design values in the event of fire	Range for characteristic values according to approvals
Flexural strength	$f_{m,f_i,d}$	27,6 N/mm ²	See Table 3-4, p.23
Tensile strength	$f_{t,0,f_i,d}$	16,1 N/mm ²	
Compressive strength in direction of fibre	$f_{c,0,f_i,d}$	24,1 N/mm ²	
Transverse compressive strength	$f_{c,90,f_i,d}$	2,9 N/mm ²	
Shear strength	$f_{v,f_i,d}$	2,9 N/mm ²	
Rolling shear strength	$f_{v,R,f_i,d}$	1,2 N/mm ²	
Torsional strength	$f_{0,T,f_i,d}$	2,8 N/mm ²	

¹ , Section 4.2.2-5.

² Timber-based materials and glued-laminated timber according to EN 1995-1-2, Table 2.1.

8 Loss of static equilibrium

For the entire structure and its parts, the static equilibrium must be guaranteed under construction and during utilisation. For cross-laminated timber buildings, in case of flat roofs or exterior facade surfaces, lift-off of elements from the supports due to wind suction must be verified and prevented with suitable fasteners.

8.1 Design situation

The verifications are undertaken in the temporary design situation (states of construction) and the rare design situation (final state). For both design situations, the following load combination with the partial safety factors from Table 8-1 must be applied.

$$E_d = \gamma_G \cdot G_{k,1} \oplus \gamma_Q \cdot Q_{k,1} \oplus \sum_{i>1} \gamma_{Q,i} \cdot \psi_{0,i} \cdot Q_{k,i} \quad (8.1)$$

Table 8-1 Partial safety factors in the limit state of loss of equilibrium (EQU)

Verifications against loss of static equilibrium	
Permanent impacts, relieving (<i>inf</i>)	$\gamma_{G,inf} = 0,90$
Variable impacts, stressing (<i>sup</i>)	$\gamma_{Q,sup} = 1,50$

8.2 Lift-off

Verification

$$F_{S,d} \leq F_{R,d} \tag{8.2}$$

$F_{S,d}$ Design value of impact on the fastener

$F_{R,d}$ Design value of resistance of the fastener

$$F_{R,d} = k_{\text{mod}} \cdot \frac{F_{R,k}}{Y_m} \tag{8.3}$$

$$F_{S,d} = Y_{G,\text{inf}} \cdot G_{1,k} - Y_Q \cdot W_{s,k} \tag{8.4}$$

In that, the following applies:

$$F_{S,d} \begin{cases} \leq 0 & \text{excess pressure – no fastener necessary} \\ > 0 & \text{discharged by fastener} \end{cases}$$

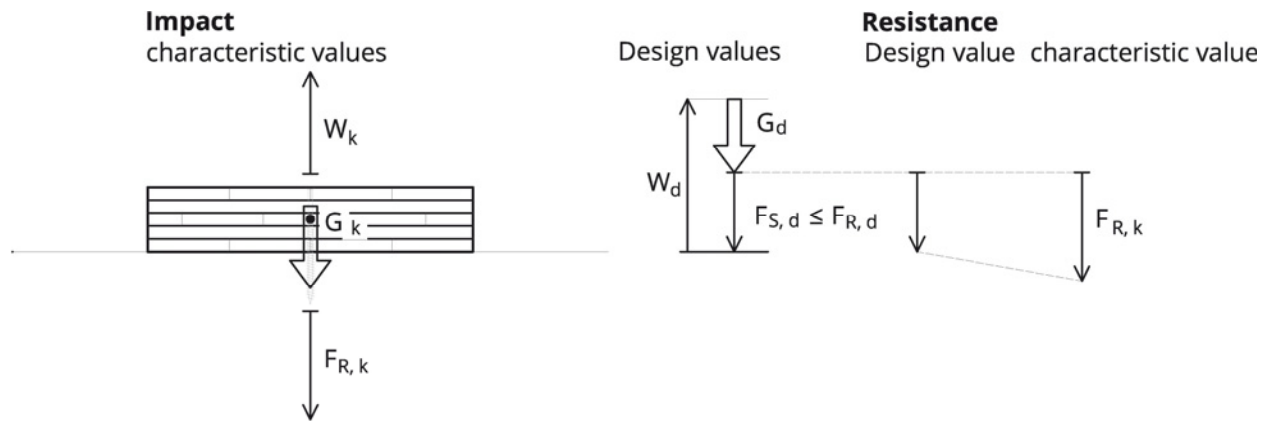

Figure 8-1: Stress against lift-off

8.2.1 Application example

Example 8-1 Lift-off of a roofing slab

Details

Cross-laminated timber elements X-Lam 100 L3s are uniaxially placed across trusses as a hall roof. The standard distance of the cross-laminated timber trusses is 5,00 m. The canopy projects by 1,05 m.

Fully threaded screws secure the roof against lift-off.

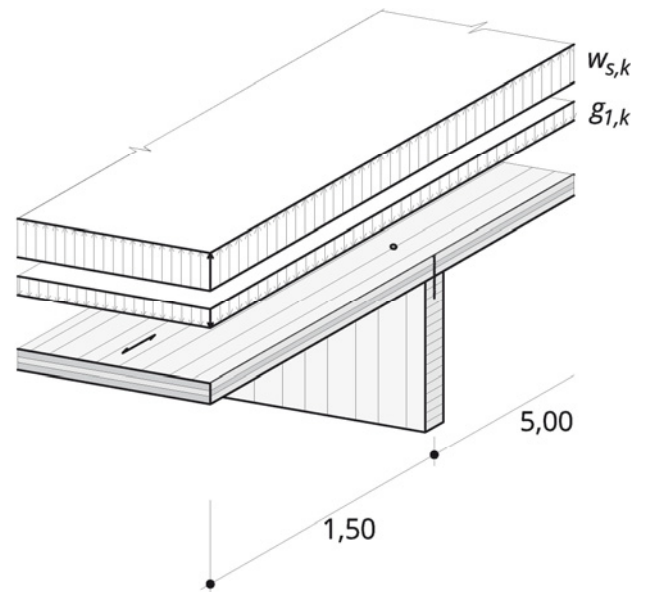

Outline conditions:

Utilisation class: NKL 1

Load duration class: KLED=brief

Impacts:

Wind suction in the canopy area:

$$w_{s,k} = 2,30 \text{ kN/m}^2$$

Dead weight of the load-bearing elements:

$$g_{1,k} = 0,40 \text{ kN/m}^2$$

(observe states of construction!)

Fasteners:

Characteristic resistance against withdrawal of a screw: $F_{R,k} = 9,00 \text{ kN}$

Calculation

Load influence width for line load at the truss:

$$b_e = 1,50 + 2,50 = 4,00 \text{ m}$$

Design value of impact per running metre of truss:

$$q_{S,d} = b_e \cdot (Y_{G,\text{sup}} \cdot g_{1,k} - Y_{Q,\text{inf}} \cdot w_{s,k})$$

$$q_{S,d} = 4,00 \cdot (0,90 \cdot 0,40 - 1,50 \cdot 2,30)$$

$$q_{S,d} = -12,36 \text{ kN/m}$$

Design value of resistance of a fastener:

$$F_{R,d} = k_{\text{mod}} \frac{F_{R,k}}{\gamma_M}$$

$$F_{R,d} = 0,90 \cdot \frac{9,00}{1,25}$$

$$F_{R,d} = 6,48 \text{ kN}$$

Statically required distance of the fasteners:

$$\text{requ. } e = \frac{F_{R,d}}{-q_{S,d}}$$

$$\text{requ. } e = \frac{6,48}{12,36}$$

$$\text{requ. } e = 0,52 \text{ m}$$

Selected distance of the fasteners:

$$\text{sel. } e = 0,45 \text{ m}$$

Verification:

$$F_{S,d} \leq F_{R,d}$$

$$\text{sel. } e \cdot q_{S,d} \leq F_{R,d}$$

$$0,45 \cdot 12,36 \leq 6,48$$

$$5,56 \leq 6,48 \quad \checkmark \text{ fulfilled (86 \%)}$$

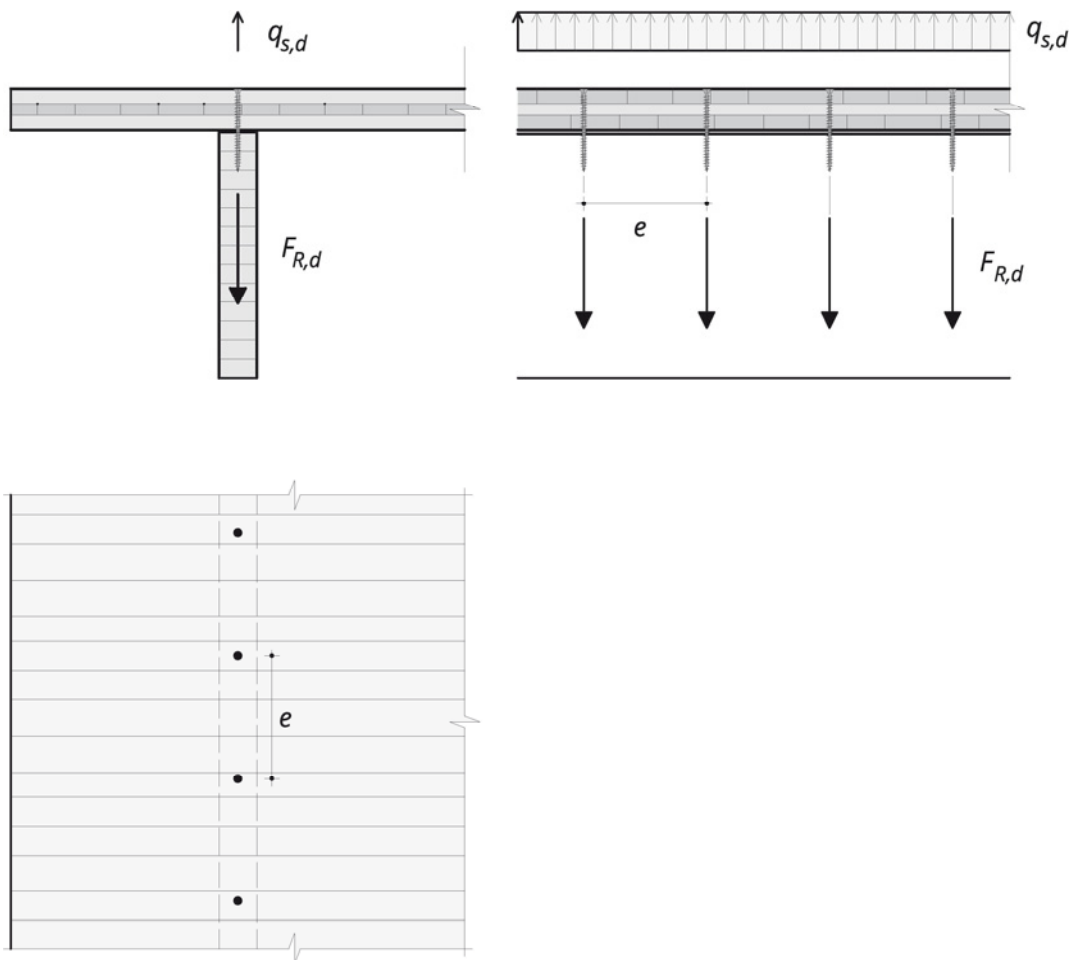

Sufficient screwing-in depth and compliance with the transverse tensile strength of the main girder must be observed.

9 Joining techniques

9.1 Butt joints

Form-fit joining is easy to execute and suitable for the material. In that, butt joints via end pressing are about eight times more efficient than via pressing transverse to the fibre.

Figure 9-1 gives an overview over a number of cases shown further below.

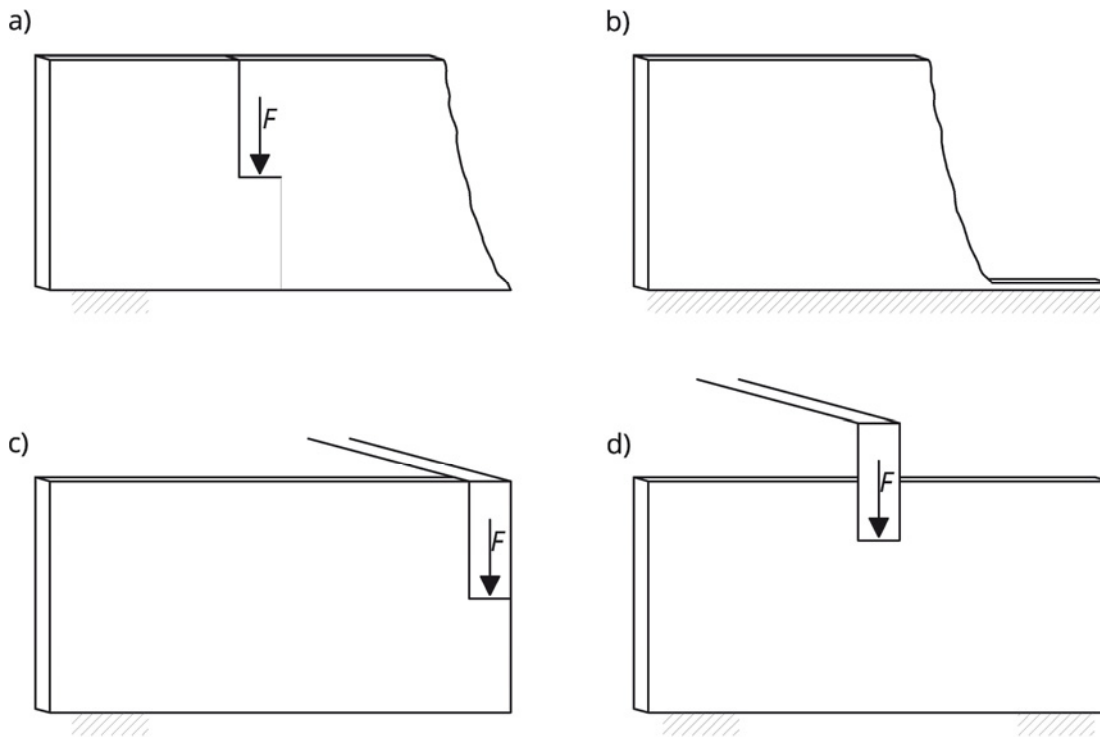

Figure 9-1: Overview over the butt joints shown

Figure 9-2 shows a support design for a notch. If the second wall element with a horizontal top layer is connected, then only side members are joined. Inserting a steel sheet, load transmission may again take place via end pressing.

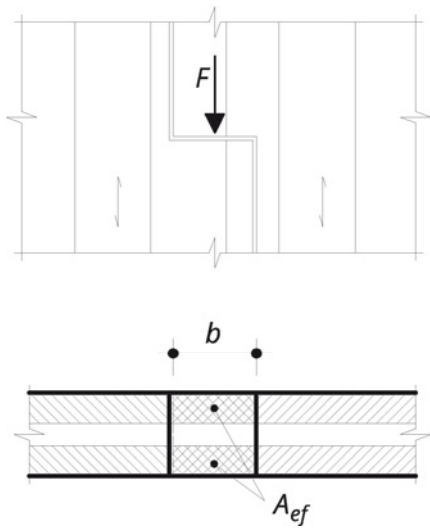

Figure 9-2: Notch in the wall plane (case a)

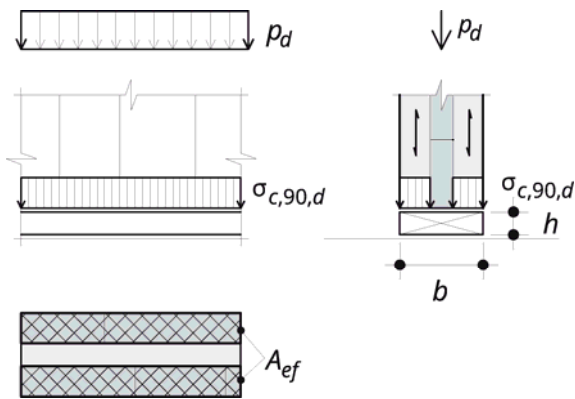

Figure 9-3: Sill pressing (case b)

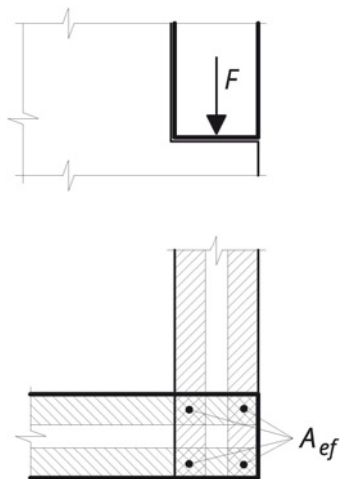

Figure 9-4: Support design for notches at an angle (case c)

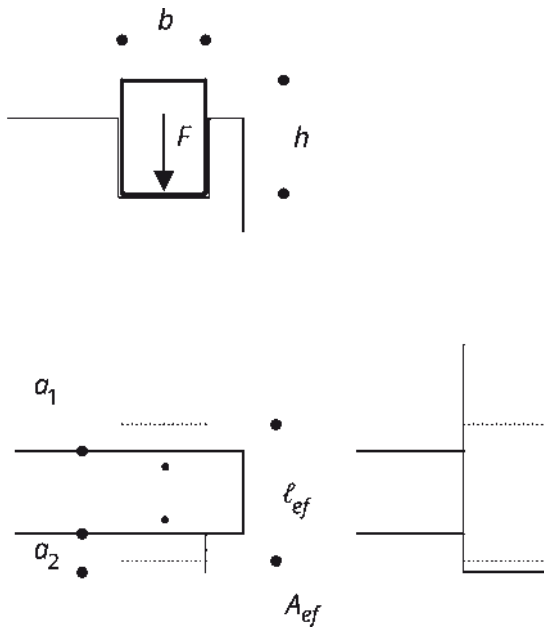

Figure 9-5: Beam support (case d)

9.2 Joint designs

This section shows frequently executed designs for various load cases as suggestions – without claiming to be exhaustive.

9.2.1 Articulated joints

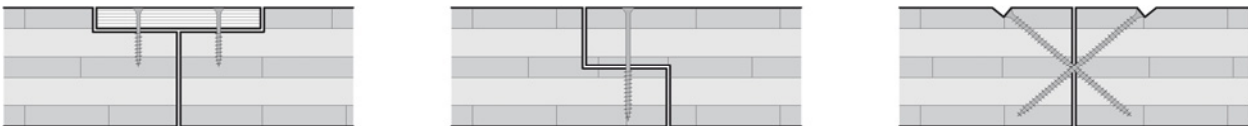

Figure 9-6: Joining along the unloaded longitudinal side by means of milled-in joint cover strip, rabbet edge or crossed fully threaded screws

In uniaxially stressed ceilings, the joints must transfer compatibility forces from the element plane. With the compatibility forces, deflections of adjacent elements are coupled, as shown in Figures 9-7a) and b).

In case of disturbances of the uniaxial load distribution, higher lateral forces V_d occur in the joints; this requires additional design measures, as shown in Figures 9-7c) and d).

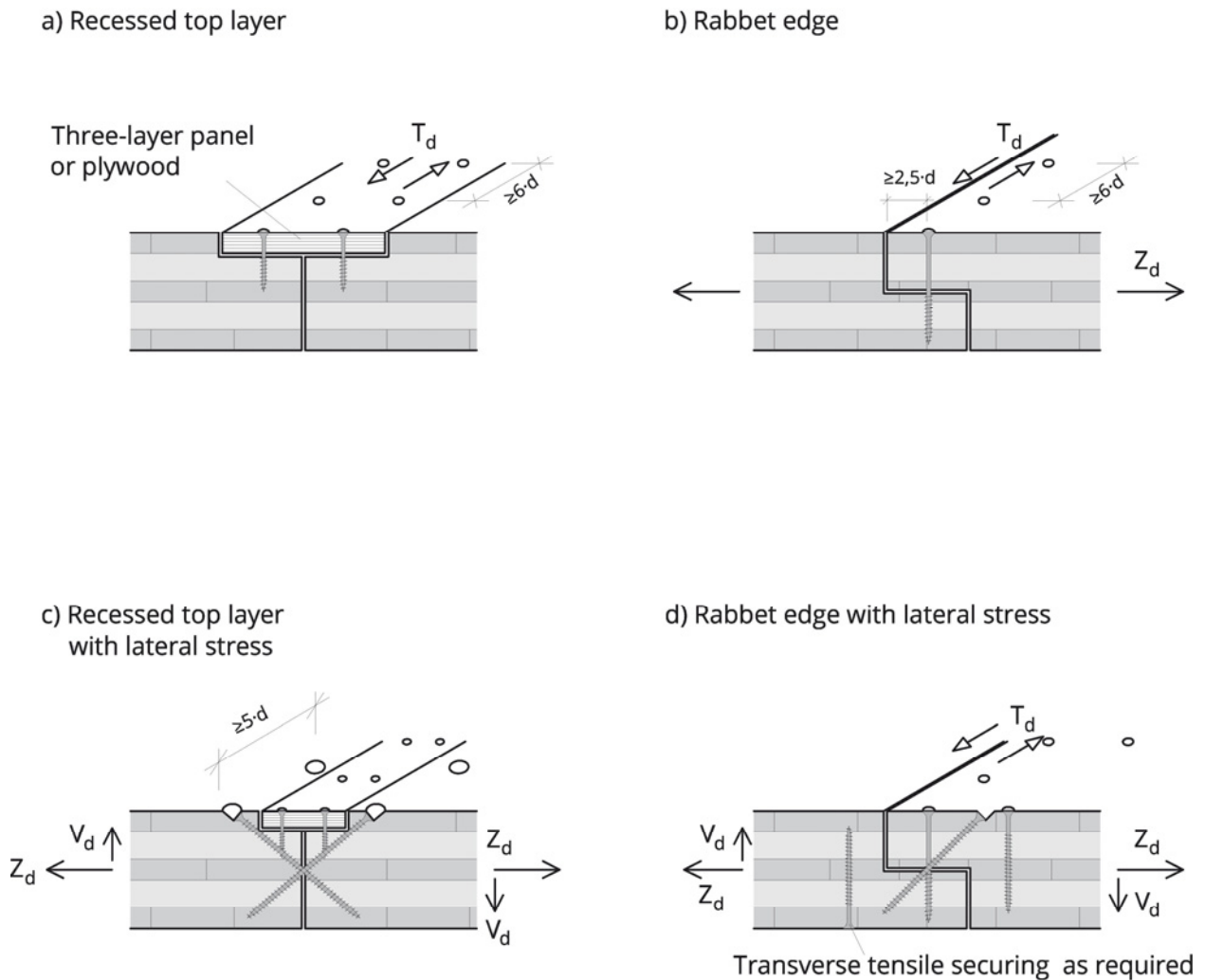

Figure 9-7: Joint design for different requirements

For the function of the ceiling span as a plate, shear forces must be transferred along the joints T_d , as shown in Figures 9-7a) and d). Tensile forces Z_d , which would result in opening of the joints, must be transferred by suitable design of the ceiling edge as a tension flange. This may take place in connection with the walls below or with suitable screwing of the ceiling elements to one another, as shown in Figures 9-7c) and d).

9.2.2 Rigid joints

Bending moments can be transferred with two-dimensional fish plates of two-dimensionally arranged squared timber, timber-based materials or steel sheets. For joints in the main direction of load-bearing capacity, exterior fish plates are normally provided (Figures 9-8a), and recessed fish plates for joints in the ancillary direction of load-bearing capacity (Figures 9-8b). For joining, screw-press adhesions are normally used. The efficiency of connections with exterior fish plates lies in the order of about 50 %. The use of top and bottom aperture plates with ring nails requires some milling and is faster. Therewith, transfer of relatively high shearing forces is enabled.

a) Rigid joint in the main direction of load-bearing capacity

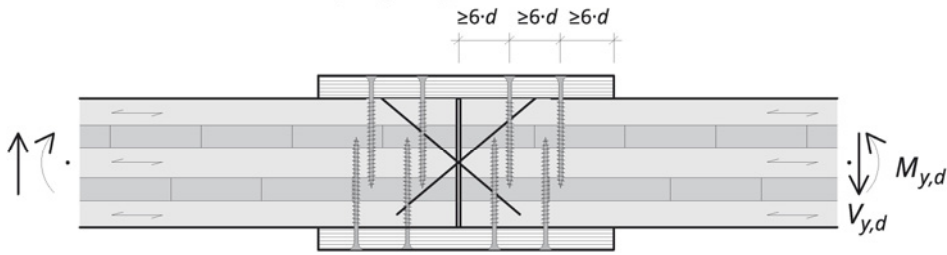

b) Rigid joint in the ancillary direction of load-bearing capacity

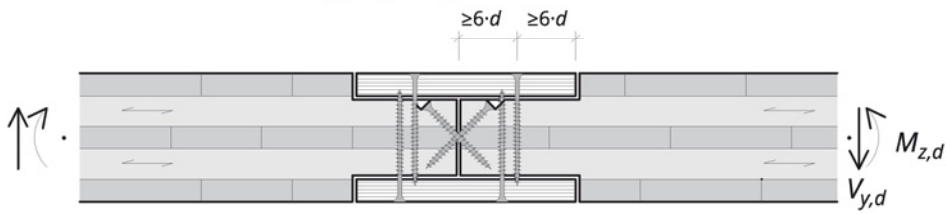

c) Rigid joint in the main direction of load-bearing capacity for thin panels

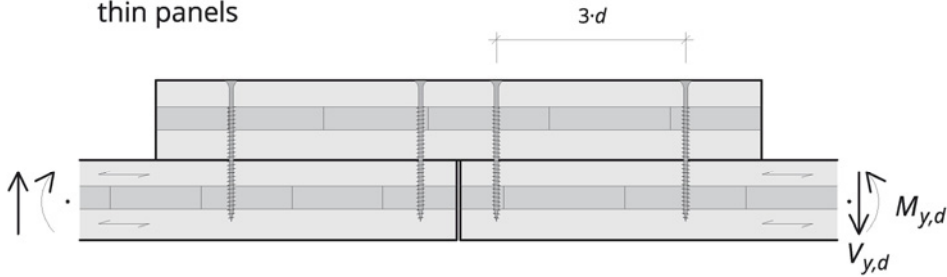

Figure 9-8: Rigid joints

9.2.3 Flush joists

Figure 9-9 shows design variants for flush joists. The design according to variant a) is suited for the transfer of vertical loads. For a continuous diaphragm, the design flush with the upper edge b) and the design flush with the lower edge c) are suggested.

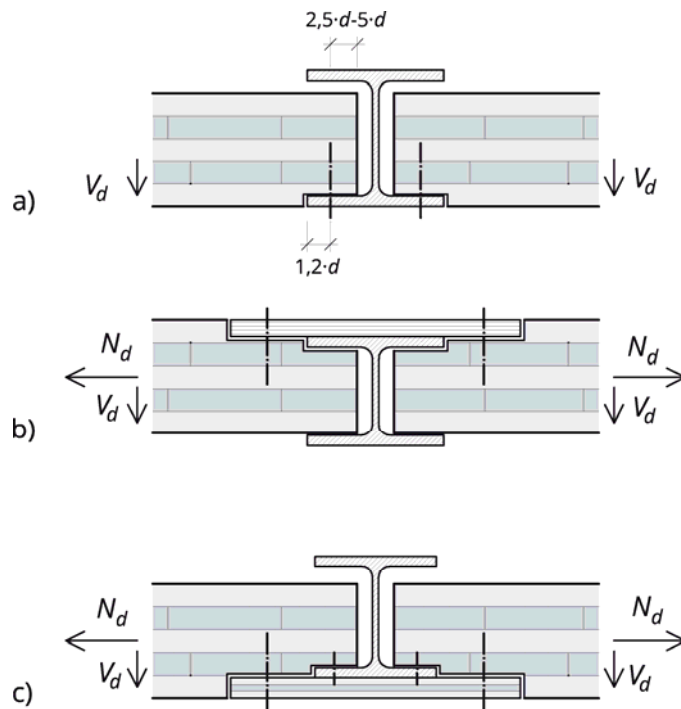

Figure 9-9: Flush joists of rolled steel sections

Table 9-1 and Table 9-2 facilitate the selection of the rolled sections by indication of the possible internal dimensions. The various manufacture-related tolerances for rolled sections¹ were added up for the internal dimensions and stated in the table.

¹ Tolerances for I-shaped rolled sections from Stahlbauzentrum Schweiz (2005).

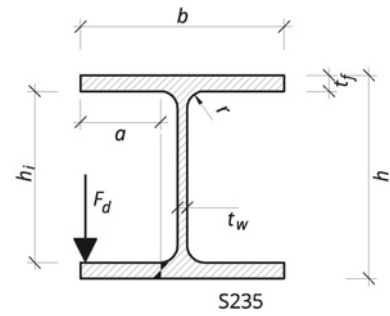

Table 9-1 HE-A for use as flush joists

	Inner Clearance height	Dimensional tolerance	max. Supporting Width		max. Supportforce from Lower Flange Bending	Section Width	Section Height	Fillet	Web Thickness	Flange Thickness	Section Modulus	Moment of Inertia
	h_i	Δh_i	a	Δa	max Fd	b	h	r	t_w	t_f	W	I
	[mm]				[kN]	[mm]				[cm ³]	[cm ⁴]	
HE-A 100	80	$\frac{-5,5}{+5,5}$	35,5	$\frac{-2,9}{+2,9}$	96	100	96	12	5,0	8,0	73	349
HE-A 120	98	$\frac{-6,4}{+6,4}$	45,5	$\frac{-3,9}{+3,9}$	75	120	114	12	5,0	8,0	106	606
HE-A 140	116	$\frac{-6,8}{+6,8}$	55,2	$\frac{-3,9}{+3,9}$	69	140	133	12	5,5	8,5	155	1 033
HE-A 160	134	$\frac{-7,2}{+7,2}$	62,0	$\frac{-3,9}{+3,9}$	69	160	152	15	6,0	9,0	220	1 673
HE-A 180	152	$\frac{-7,6}{+7,6}$	72,0	$\frac{-3,9}{+3,9}$	66	180	171	15	6,0	9,5	294	2 510
HE-A 200	170	$\frac{-8,5}{+9,5}$	78,7	$\frac{-3,9}{+3,9}$	67	200	190	18	6,5	10,0	389	3 692
HE-A 220	188	$\frac{-8,9}{+9,9}$	88,5	$\frac{-4,0}{+4,0}$	73	220	210	18	7,0	11,0	515	5 410
HE-A 240	206	$\frac{-9,3}{+10,3}$	95,2	$\frac{-4,0}{+4,0}$	80	240	230	21	7,5	12,0	675	7 763
HE-A 260	225	$\frac{-9,7}{+10,7}$	102,2	$\frac{-4,0}{+4,0}$	81	260	250	24	7,5	12,5	836	10 450
HE-A 280	244	$\frac{-10,1}{+11,1}$	112,0	$\frac{-4,0}{+4,0}$	80	280	270	24	8,0	13,0	1 013	13 670
HE-A 300	262	$\frac{-10,5}{+11,5}$	118,7	$\frac{-4,0}{+4,0}$	88	300	290	27	8,5	14,0	1 260	18 260
HE-A 320	279	$\frac{-10,5}{+11,5}$	118,5	$\frac{-4,0}{+4,0}$	108	300	310	27	9,0	15,5	1 479	22 930
HE-A 340	297	$\frac{-10,5}{+11,5}$	118,2	$\frac{-4,0}{+4,0}$	123	300	330	27	9,5	16,5	1 678	27 690
HE-A 360	315	$\frac{-10,5}{+11,5}$	118,0	$\frac{-4,3}{+4,3}$	138	300	350	27	10,0	17,5	1 891	33 090
HE-A 400	352	$\frac{-10,5}{+11,5}$	117,5	$\frac{-4,3}{+4,3}$	164	300	390	27	11,0	19,0	2 311	45 070

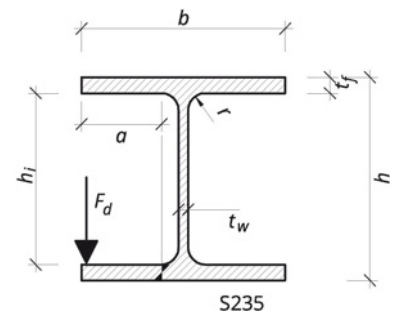

Table 9-2 HE-B for use as flush joists

	Inner Clearance height	Dimensional tolerance	max. Supporting Width		max. Supportforce from Lower Flange Bending	Section Width	Section Height	Fillet	Web Thickness	Flange Thickness	Section Modulus	Moment of Inertia
	h_i	Δh_i	a	Δa	max Fd	b	h	r	t_w	t_f	W	I
	[mm]		[mm]		[kN]	[mm]				[cm ³]	[cm ⁴]	
HE-B 100	80	$\frac{-6,0}{+6,0}$	35,0	$\frac{-2,9}{+2,9}$	152	100	100	12	6,0	10,0	90	450
HE-B 120	98	$\frac{-6,9}{+6,9}$	44,7	$\frac{-3,9}{+3,9}$	144	120	120	12	6,5	11,0	144	864
HE-B 140	116	$\frac{-7,3}{+7,3}$	54,5	$\frac{-4,0}{+4,0}$	141	140	140	12	7,0	12,0	216	1 509
HE-B 160	134	$\frac{-7,7}{+7,7}$	61,0	$\frac{-4,0}{+4,0}$	147	160	160	15	8,0	13,0	312	2 492
HE-B 180	152	$\frac{-8,1}{+8,1}$	70,7	$\frac{-4,0}{+4,0}$	148	180	180	15	8,5	14,0	426	3 831
HE-B 200	170	$\frac{-8,5}{+9,5}$	77,5	$\frac{-4,0}{+4,0}$	155	200	200	18	9,0	15,0	570	5 696
HE-B 220	188	$\frac{-8,9}{+9,9}$	87,2	$\frac{-4,0}{+4,0}$	156	220	220	18	9,5	16,0	736	8 091
HE-B 240	206	$\frac{-9,3}{+10,3}$	94,0	$\frac{-4,3}{+4,3}$	164	240	240	21	10,0	17,0	938	11 260
HE-B 260	225	$\frac{-9,7}{+10,7}$	101,0	$\frac{-4,3}{+4,3}$	161	260	260	24	10,0	17,5	1 148	14 920
HE-B 280	244	$\frac{-10,1}{+11,1}$	110,7	$\frac{-4,3}{+4,3}$	156	280	280	24	10,5	18,0	1 376	19 270
HE-B 300	262	$\frac{-10,5}{+11,5}$	117,5	$\frac{-4,3}{+4,3}$	164	300	300	27	11,0	19,0	1 678	25 170
HE-B 320	279	$\frac{-10,5}{+12,0}$	117,2	$\frac{-4,3}{+4,3}$	191	300	320	27	11,5	20,5	1 926	30 820
HE-B 340	297	$\frac{-10,5}{+12,0}$	117,0	$\frac{-4,3}{+4,3}$	211	300	340	27	12,0	21,5	2 156	36 660
HE-B 360	315	$\frac{-10,5}{+12,0}$	116,7	$\frac{-4,3}{+4,3}$	231	300	360	27	12,5	22,5	2 400	43 190
HE-B 400	352	$\frac{-10,5}{+12,0}$	116,2	$\frac{-4,3}{+4,3}$	264	300	400	27	13,5	24,0	2 884	57 680

9.3 Pin-type fasteners and their load-bearing capacity

9.3.1 General

The load-bearing capacity of pin-type fasteners in cross-laminated timber elements is regulated differently:

Some product approvals include regulations on mechanical fasteners; in part, reference is made to Eurocode 5 for determination of the load-bearing capacity of the fasteners. In some technical approvals, fasteners in cross-laminated timber are described separately.

In practice, determination of the load-bearing capacity of fasteners is commonly performed according to Blaß und Uibel (2009). On the basis of a comprehensive research project about the load-bearing and deformation behaviour of pin-type fasteners in cross-laminated timber, structural design suggestions for connections in the surfaces (also called lateral faces) and front faces (also called narrow sides) were developed by Blaß und Uibel (2007) at the Institute for Timber Engineering and Structural Design of Karlsruhe University of Applied Sciences (TH Karlsruhe). These structural design suggestions were in part considered in the approvals for cross-laminated timber elements. At Graz University of Technology (TU Graz), research projects of the subject were likewise performed by Schickhofer et al. (2010). Finally, it should be noted that European technical approvals for screws in cross-laminated timber are already present.

9.3.2 Minimum design screw connection

The specification of a minimum design screw connection in joints of load-bearing cross-laminated timber elements, as, for example, between adjacent ceiling elements, between ceiling and wall or between two walls, is continuously discussed. The authors advise designers, depending on the respective building project, to specify a minimum design screw connection for the entire project (for example three pieces of self-tapping fully threaded screws $d = 8 \text{ mm}$, $e \leq 33 \text{ cm}$, with specification of the screw-in depth depending on the element thickness).

9.4 Self-tapping woodscrews

With predominantly static load, the use of woodscrews with a minimum tensile strength of $f_{u,k} = 800 \text{ N/mm}^2$ is assumed. For dynamic alternating stress, separate considerations must be undertaken.

9.4.1 Withdrawal of self-tapping woodscrews

The axial load-bearing capacity of connections with self-tapping woodscrews depends on the resistance against withdrawal, the tensile load-bearing capacity of the screw's core cross-section and, for partially threaded screws, on the resistance against pulling through.

For fully or partially threaded self-tapping woodscrews, the characteristic value of the resistance against withdrawal can be calculated according to Blaß und Uibel (2009) as follows:

$$F_{ax,k} = \frac{31 \cdot d^{0,8} \cdot \ell_{ef}^{0,9}}{1,5 \cdot \cos^2 \varepsilon + \sin^2 \varepsilon} \quad (9.1)$$

- $F_{ax,k}$ Resistance against withdrawal (characteristic value) in [N]
- d Nominal diameter of the screw in [mm] (outer thread diameter)
- ℓ_{ef} ... Effective screw-in depth in [mm], including the screw tip
- $\ell_{ef,min} = 4 \cdot d$
- ε Screw-in angle to the fibre

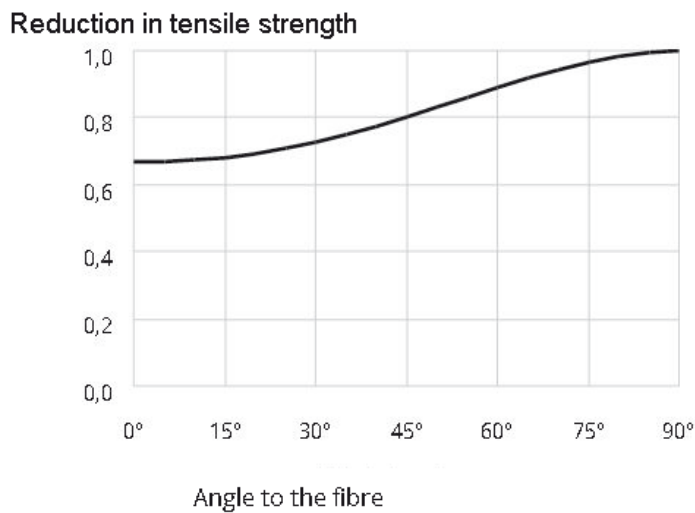

Figure 9-10: Reduction in tensile strength as a function of the angle to the fibre

For $f_{u,k} = 800 \text{ N/mm}^2$ load-bearing capacity class 3 according to DIN 1052, the tensile load-bearing capacity of the screw in the core cross-section can be determined according to the following formula. According to the approvals of the different screws, higher load-bearing capacities are achieved at times.

$$F_{ax,k} = f_{u,k} \cdot \frac{d_1^2 \cdot \pi}{4} = f_{u,k} \cdot \frac{(0,6 \cdot d)^2 \cdot \pi}{4} = 800 \cdot \frac{(0,6 \cdot d)^2 \cdot \pi}{4} \quad (9.2)$$

For a connection with a group of screws, the statically effective number has to be determined as follows¹:

$$n_{ef} = n^{0,9} \quad (9.3)$$

¹ EN 1995-1-1, Paragraph 8.7.2 (8).

9.4.2 Withdrawal of screws from the front face

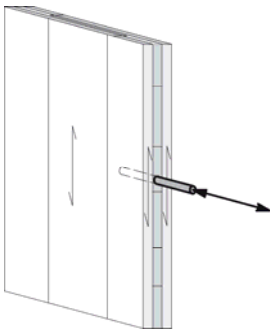

Figure 9-11: Fasteners in the front face (also narrow side) subject to withdrawal

Prerequisites:

- Thread diameter of the screws: $d \geq 8 \text{ mm}$
- Core diameter of the screws: $d_1 \geq 0,6 \cdot d$
- Minimum timber thickness
Individual layer: $t_1 \geq 3 \cdot d$ [mm]
Cross-laminated timber element: $t_{CLT} \geq 10 \cdot d$ [mm]
- Minimum screw-in depth $\ell_{ef} \geq 10 \cdot d$
- At least two screws per row of fasteners
- For front-face screw connections, the bulk density of the board layers is used ($\rho_k = 350 \text{ kg/m}^3$).

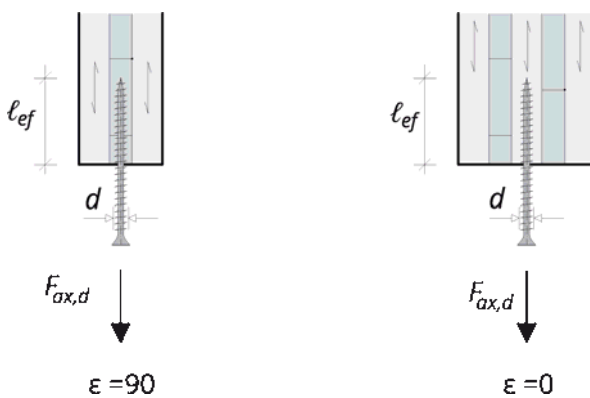

Figure 9-12: Stress in front-face screw connections

For tensile connections in the front face of cross-laminated timber, normally it cannot be ensured that the screw gets to rest in the centre of a side member. Therefore, it is conservatively assumed that the screw axis lies in the direction of the fibre ($\varepsilon = 0$ in equation (9.1)).

$$F_{ax,k} = \frac{31 \cdot d^{0,8} \cdot l_{ef}^{0,9}}{1,5} \text{ [N]} \quad (9.4)$$

So far, there are only few findings about the long-term behaviour of screws screwed in in parallel to the fibre. Long-term tests are currently undertaken at Karlsruhe University, which point towards lower load-bearing capacities of woodscrews screwed in in parallel to the fibre. In order to prevent transverse tensile failure, transverse tensile securing with additional transverse screw connections is recommended.

Therefore, it is recommended to screw the screws only into layers transverse to the fibre, until the test results for tension become available.

For load application of tensile forces in the element plane, the authors suggest compliance with a minimum inclination of 30° to the direction of fibre, in order to prevent screws resting in the end grain, as shown in Figure 9-13 and Figure 9-14. The resistance of the screws against withdrawal from the timber should be reduced to 50 % due to the long-term load-bearing capacity mentioned.

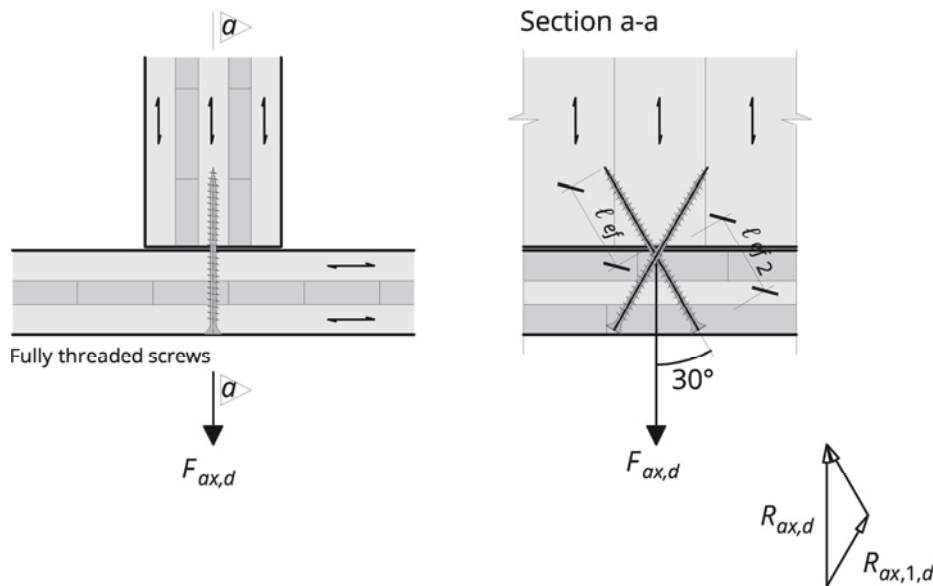

Figure 9-13: Suspension using fully threaded screws inclined in the wall plane

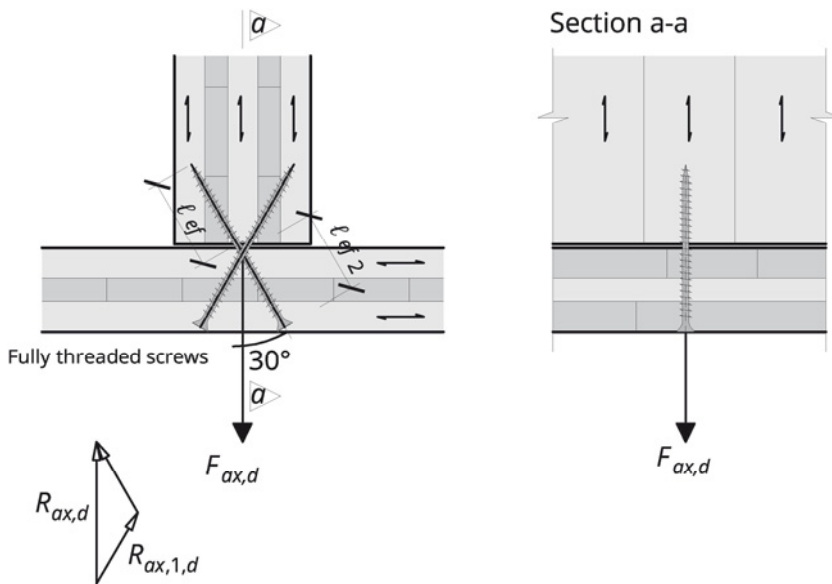

Figure 9-14: Suspension using fully threaded screws inclined out of the wall plane

Table 9-3 Resistances against withdrawal of screw pairs

		Extraction Resistance $R_{ax,d}$ in [kN]	
		per screw-pair (30°) Pull-out 50 %	
d [mm]		8	10
Thread Length L_{ef} (side of screw tip) [mm]	60		
	65	2,21	
	70	2,36	
	75	2,51	
	80	2,66	3,18
	85	2,81	3,36
	90	2,96	3,53
	95	3,10	3,71
	100	3,25	3,89
	105	3,40	4,06
	110	3,54	4,23
	115	3,69	4,41
	120	3,83	4,58
	125	3,97	4,75
	130	4,12	4,92
135	4,26	5,09	
140	4,40	5,26	

The resistances against withdrawal in Table 9- apply to up to four pairs of screws acting together and a medium load duration ($k_{\text{mod}} = 0,80$, NKL 1 and 2). The thread length l_{ef} can be retrieved from Figure 9-13. For other numbers of pairs of screws, the design values must be multiplied with the following conversion factors:

Table 9-3 Conversion factors per number of pairs of screws

Number of Screw-Pairs	1	2	4	8	12	16
Factor	1,15	1,07	1,00	0,93	0,90	0,87

For connection of two cross-laminated timber elements, the screw-in depth $l_{ef,2}$ designated in Figure 9-13 and Figure 9-14 must be complied with in the transverse element: $l_{ef,2} \geq 0,8 \cdot l_{ef}$.

Minimum distances and minimum dimensions

The minimum distances can be retrieved from the screw approvals. For limitation of the distances, the following values are stated: distance among one another $a_1 = a_2 = 5 \cdot d$. Minimum thickness of the element $10 \cdot d$, minimum width of the element $8 \cdot d$.

9.4.3 Withdrawal of screws from the cross-laminated timber surface

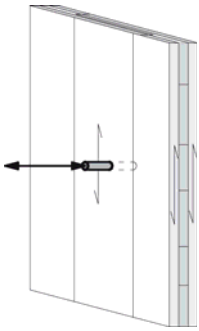

Figure 9-15: Fasteners in the surface (also lateral face) subject to withdrawal

Prerequisites:

- Thread diameter of the screws: $d \geq 6$ mm
- Core diameter of the screws: $d_1 \geq 0,6 \cdot d$
- At least two screws per connection or per row of fasteners, respectively
- Screwing-in depth at least three board layers and $l_{ef} \geq 8 \cdot d$
- For screw connections in the surface, the bulk density of the overall cross-section is used ($\rho_k = 400 \text{ kg/m}^3$)

For screw connections in the surface, with $\varepsilon = 90$, the following results from equation (9.1):

$$R_{ax,k} = 31 \cdot d^{0,8} \cdot l_{ef}^{0,9} \text{ [N]} \quad (9.5)$$

Table 9-4 Withdrawal resistances of screws

		Extraction Resistance from the Element Surface $R_{ax,d}$ in [kN]	
		je Schraube	
d [mm]		8	10
Thread Length L_{ef} [mm]	60		
	65	3,75	
	70	4,01	
	75	4,27	
	80	4,52	5,41
	85	4,78	5,71
	90	5,03	6,01
	95	5,28	6,31
	100	5,53	6,61
	105	5,78	6,91
	110	6,03	7,20
	115	6,27	7,50
	120	6,52	7,79
	125	6,76	8,08
	130	7,00	8,37
135	7,25	8,66	
140	7,49	8,95	

The withdrawal resistances apply to up to four screws acting jointly for a medium load duration ($k_{mod} = 0,80$, utilisation classes 1 and 2). For any other number of screws, the design values must be multiplied with the following conversion factors:

Table 9-6 Conversion factors per number of screws

Number of Screws	2	4	8	12	16
Factor	1,07	1,00	0,93	0,90	0,87

Minimum distances and minimum dimensions

The minimum distances can be retrieved from the screw approvals. For limitation of the distances, the following values are stated: distance among one another longitudinal and transverse to the direction of the top layer $a_1 = a_2 = 5 \cdot d$, minimum thickness of the element $10 \cdot d$, minimum width of the element $8 \cdot d$.

9.4.4 Shearing-off of screws

9.4.5 Shearing-off of screws in the front face

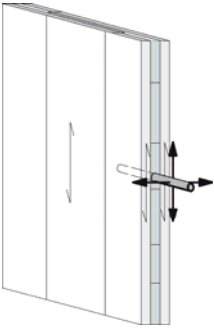

Figure 9-16: Fasteners in the front face subject to shearing-off

Prerequisites:

- Minimum diameter of the screws: $d \geq 8 \text{ mm}$
- Minimum screw-in depth: $l_{ef} \geq 10 d$

For self-tapping woodscrews, according to Blaß und Uibel (2007), a characteristic value of the embedding strength can be calculated as follows

$$f_{h,k} = \frac{20}{\sqrt{d}} \text{ [N/mm}^2\text{]} \quad (9.6)$$

d.....Nominal diameter of the screws in [mm]

The screws can be screwed into long grain as well as end grain of the front face. Possible joints between the boards of no more than 6 mm (see 2.1.1.) may remain unconsidered.

Embedding strength for fully threaded screws in the narrow side

$$\text{for } d = 8 \text{ mm: } f_{h,k} = 7,07 \text{ N/mm}^2$$

$$\text{for } d = 10 \text{ mm: } f_{h,k} = 6,33 \text{ N/mm}^2$$

The load-bearing capacity of the fastener must be determined according to the Johansen theory and the formulas from EN 1995-1-1, Paragraph 8.2.2.

Upon connection with a group of screws, the statically effective number of consecutive screws must be determined as follows¹:

$$n_{ef} = n^{0,85} \quad (9.7)$$

This value applies to a screw distance of $a_1 \geq 10 \cdot d$; from $a_1 \geq 14 \cdot d$, the reduction may be omitted¹

¹ EN 1995-1-1, Paragraph 8.7.2 (8)

Minimum distances

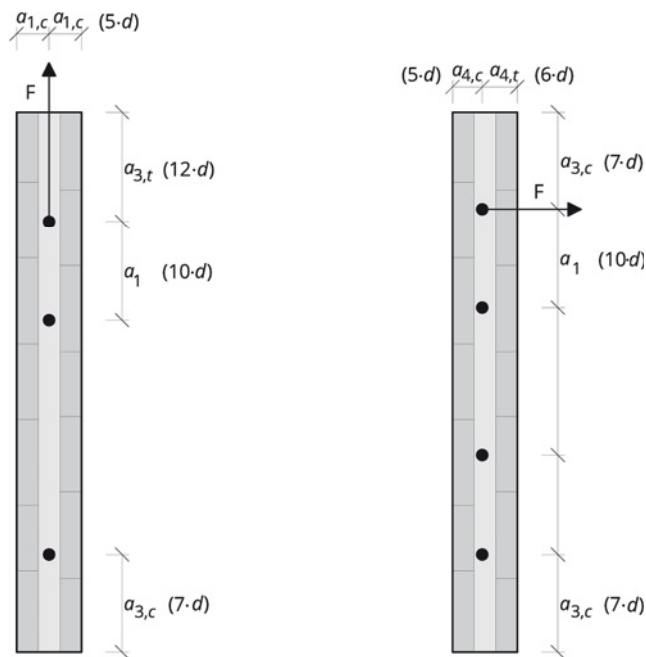

Figure 9-17: Minimum distances of self-tapping woodscrews in the narrow side

Table 9-7 Minimum distances of self-tapping woodscrews in the narrow side

Distance	in the direction of the element side	a_1	$10 \cdot d$
	transverse to the element surface	a_2	$3 \cdot d$
Edge distance	stressed edge	$a_{3,t}$	$12 \cdot d$
	non-stressed edge of the top layer	$a_{3,c}$	$7 \cdot d$
	stressed edge to the element surface	$a_{4,t}$	$6 \cdot d$
	non-stressed edge to the element surface	$a_{4,c}$	$5 \cdot d$

9.4.6 Shearing-off of screws in the element surface

The optimal arrangement of fully threaded screws is in the direction of load, since the tensile load-bearing capacity is many times higher and thus the economy increases.¹

¹ See also EN 1995-1-1, Table 8.1. This Table is referenced in some Technical Approvals for fully threaded screws

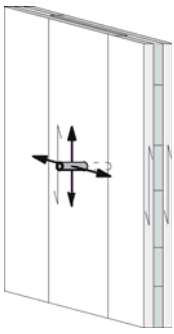

Figure 9-18: Fasteners in the surface subject to shearing-off

Prerequisites:

- Minimum diameter of the screws: $d \geq 6 \text{ mm}$
- Cross-laminated timber with board layer thicknesses $t_i \geq 10 \text{ mm}$
- Screw-in depth at least three board layers

For **fully threaded** self-tapping woodscrews, the embedding strength can be calculated according to Blaß und Uibel (2007):

$$f_{h,k} = 0,019 \cdot \rho_{B,k}^{1,24} \cdot d^{-0,3} \text{ N/mm}^2 \tag{9.8}$$

d Nominal diameter of the screws in [mm]

$\rho_{B,k}$ Characteristic bulk density of the starting material in kg/m^3

(recommended: for C24 $\rho_{B,k} = 350 \text{ kg/m}^3$)

Embedding strength for fully threaded screws in the element surface

for $d = 6 \text{ mm}$: $f_{h,k} = 15,84 \text{ N/mm}^2$

for $d = 8 \text{ mm}$: $f_{h,k} = 14,54 \text{ N/mm}^2$

for $d = 10 \text{ mm}$: $f_{h,k} = 13,60 \text{ N/mm}^2$

The load-bearing capacity of the fastener must be determined according to the Johansen theory and the formulas from EN 1995-1-1, 8.2.2.

For connection with a group of screws in the element surface, it is not necessary to reduce the statically effective number of fasteners. With the element build-up, transverse tensile reinforcement can be assumed; brittle failure by splitting does not occur.

$$n_{ef} = n \tag{9.9}$$

Note: Depending on the respective manufacturer of the fasteners, reductions are stated, if the fasteners are arranged consecutively in the direction of fibre.

In the following, various applications are analysed according to this theory, taking the embedding strengths according to Blaß und Uibel (2007) as a basis:

Minimum distances

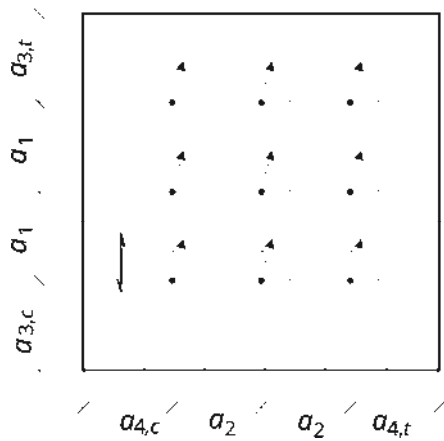

Figure 9-19: Designation of the minimum distances of screws in the element surface

The minimum distances are regulated in the product approvals of the screw manufacturers; designation of the minimum distances is undertaken according to Figure 9-19. Normally, the minimum distances according to Table 9- apply¹, which are undercut in some product approvals.

Table 9-8 Minimum distances of self-tapping woodscrews in the element surface

			Load in the	Load at angle α to the	Load transverse to the
			Direction of fibre of the top layer		
Distance	in the direction of fibre of the top layer	a_1	$4 \cdot d$	$(4 + \cos \alpha) d$	$5 \cdot d$
	at right angles to the direction of fibre of the top layer	a_2	$2,5 \cdot d$	$(2,5 + 1,5 \sin \alpha) d$	$4 \cdot d$
Edge distance	stressed edge of the top layer	$a_{3,t}$	$6 \cdot d$	$(7 - \cos \alpha) d$	$7 \cdot d$
	non-stressed edge of the top layer	$a_{3,c}$	$6 \cdot d$		
	stressed edge of the transverse layer	$a_{4,t}$	$6 \cdot d$	$(6 + \sin \alpha) d$	$7 \cdot d$
	non-stressed edge of the transverse layer	$a_{4,c}$	$2,5 \cdot d$		

The minimum distances of the screws to the edges are shown in Figure 9-20 in the form of a template. The template must be positioned such that the direction of fibre of the top layer corresponds to the direction indicated and the screw force lies in the hatched area. The edge distances at the stressed edges depending on the load angle α can be read via the curves entered.

¹ Corresponding to ÖNORM prB 1995-1-1:2013 draft of Austrian national annex

Edge distances of a screw by load direction

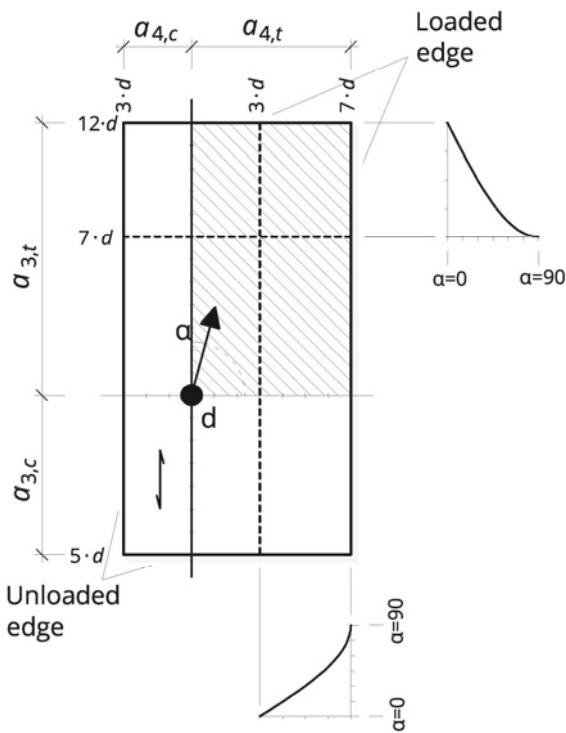

Figure 9-20: Template for minimum distances of screws in the element surface to the element edge

The minimum distances of the screws among one another are shown in Figure 9-20 as a template. The template must be positioned such that the direction of fibre of the top layer corresponds to the direction indicated and the screw force lies in the hatched area. The edge distances at the stressed edges depending on the load angle α can be read via the curves entered.

Distances of screws among one another

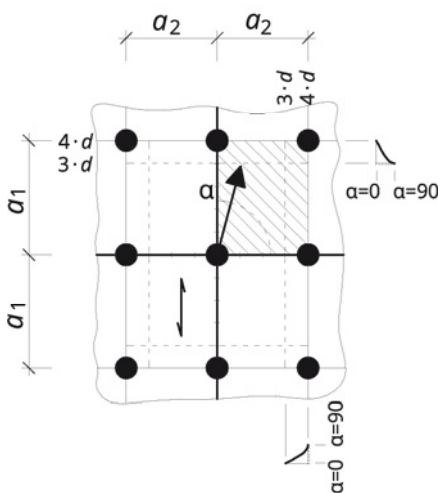

Figure 9-21: Template for minimum distances of screws in the element surface among one another

Pre-design tables for shearing-off of self-tapping woodscrews

Design values for connection of a cross-laminated timber ceiling to a beam made of solid or glued-laminated timber. Assumptions: $k_{mod} = 0,8$, $\gamma_m = 1,3$, suspension effect considered: $R_{v,d} = F_{v,d} + 0,25 \cdot F_{ax,d}$.

Table 9-9 Resistance against shearing-off – partially threaded screws (TGS)

	$R_{v,d}$ [kN/pc.] for partially threaded screws with countersunk head ¹	
	$d = 8 \text{ mm}$	$d = 10 \text{ mm}$
Long-grain timber thickness $t_1 = 60\text{--}200 \text{ mm}$ Screw-in length $\ell_{ef} \geq 80 \text{ mm}$	1,50	2,20

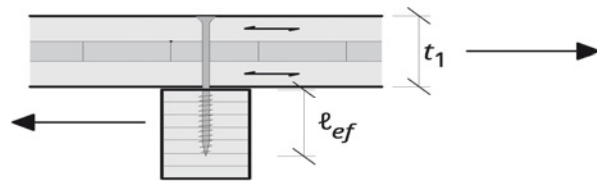

Solid timber, glued-laminatd timber

Figure 9-22: Shearing-off of self-tapping woodscrews

Table 9-10 Resistance against shearing-off – fully threaded screws (VGS) $d = 8 \text{ mm}$

Long-grain timber thickness t_1 [mm]	$R_{v,d}$ [kN/pc.] for fully threaded screws with $d = 8 \text{ mm}$		
	60	80	100 – 200
Screw-in length $\ell_{ef} \geq 80 \text{ mm}$	2,63	2,63	2,63
Screw-in length $\ell_{ef} = 100 \text{ mm}$	2,79	2,85	2,85
Screw-in length $\ell_{ef} \geq 120 \text{ mm}$	2,79	3,06	3,06

Table 9-11 Resistance against shearing-off – fully threaded screws $d = 10 \text{ mm}$

Long-grain timber thickness t_1 [mm]	$R_{v,d}$ [kN/pc.] for fully threaded screws with $d = 10 \text{ mm}$		
	60	80	100–220
Screw-in length $\ell_{ef} \geq 100 \text{ mm}$	3,53	4,02	4,02
Screw-in length $\ell_{ef} = 120 \text{ mm}$	3,53	4,25	4,28
Screw-in length $\ell_{ef} \geq 140 \text{ mm}$	3,53	4,25	4,54

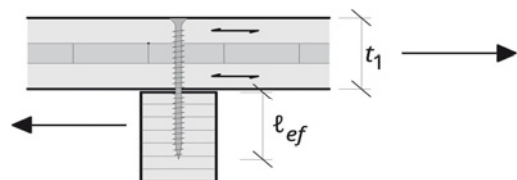

Solid timber, glued-laminatd timber

Figure 9-23: Pre-design tables for shearing-off of self-tapping woodscrews

¹ Assumed screw head diameter: $d_k = 1,8 \cdot d$.

Design values for connection of a cross-laminated timber ceiling to a wall made of cross-laminated timber. Assumptions: $k_{mod} = 0,8$, $\gamma_m = 1,3$. Suspension effect considered: $R_{V,d} = F_{V,d} + 0,25 \cdot F_{ax,d}$.

Table 9-12 Resistance against shearing-off – partially threaded screws (TGS), X-LAM to X-LAM

Screw diameter d	$R_{V,d}$ [kN/pc.]	
	$d = 8 \text{ mm}$	$d = 10 \text{ mm}$
Long-grain timber thickness $t_1 = 60\text{--}200 \text{ mm}$ Screw-in length $\ell_{ef} \geq 100 \text{ mm}$	1,24	1,80

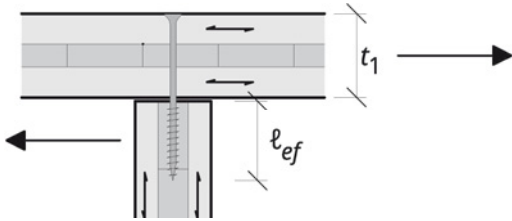

Figure 9-24: Resistance against shearing-off for partially threaded screws

Table 9-13 Resistance against shearing-off – fully threaded screws (VGS) $d = 8 \text{ mm}$, X-LAM to X-LAM

Long-grain timber thickness t_1 [mm]	$R_{V,d}$ [kN/pc.]		
	for fully threaded screws with $d = 8 \text{ mm}$		
	60	80	100 – 200
Screw-in length $\ell_{ef} \geq 80 \text{ mm}$	2,18	2,18	2,18
Screw-in length $\ell_{ef} = 100 \text{ mm}$	2,43	2,49	2,49
Screw-in length $\ell_{ef} \geq 120 \text{ mm}$	2,43	2,68	2,68

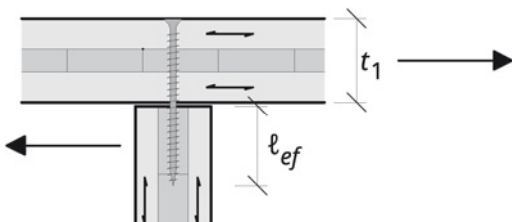

Figure 9-25: Resistance against shearing-off for fully threaded screws $d = 8 \text{ mm}$

¹ Assumed screw head diameter $d_k = 1,8 \cdot d$

Table 9-14 Resistance against shearing-off – fully threaded screws $d = 10$ mm, X-LAM to X-LAM

Long-grain timber thickness t_1	$R_{v,d}$ [kN/pc.] for fully threaded screws with $d = 10$ mm		
	60	80	100–220
Screw-in length $\ell_{ef} \geq 100$ mm	2,98	3,12	3,12
Screw-in length $\ell_{ef} = 120$ mm	3,08	3,52	3,52
Screw-in length $\ell_{ef} \geq 140$ mm	3,08	3,59	3,75

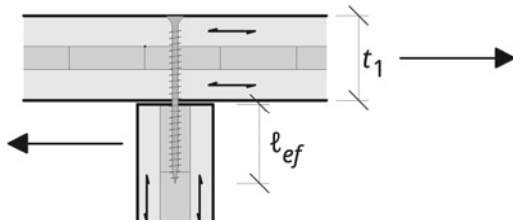

Figure 9-26: Resistance against shearing-off for fully threaded screws $d = 10$ mm

10 Bracing of buildings

In the following chapter, the essential aspects for bracing of buildings are contemplated. Following description of the impacts, stability and storey-wise force progression are examined. For diaphragms and shear walls, the effects of the impact forces on individual elements are discussed. The requirements to joining techniques and respective verifications conclude the sections on the two structural elements.

10.1 Impacts and design situations

10.1.1 Wind

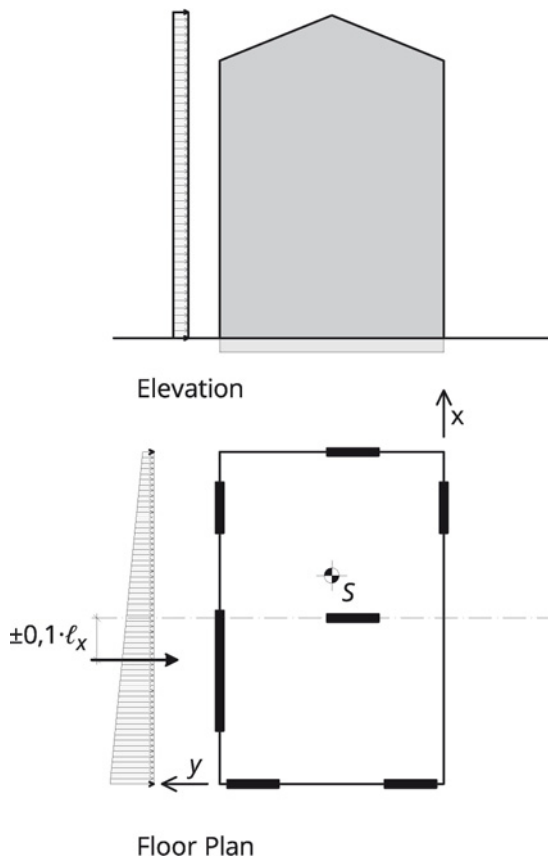

Figure 10-1: Wind load with eccentricity

For buildings with only few storeys, the wind load is almost constant across the height. The impact per storey results from the sum of the storeys above.

Irregular incident wind flows are considered with a load application eccentric compared to the vertical building axis. The eccentricity is determined at 10 % of the building length subject to the incident flow.¹ Considering this eccentricity, the wind load may be considered separated into the one and the other building axis.

¹ According to ÖNORM B 1991-1-4:2011, Section 4.5.1. and according to DIN 1055-4:2005, Section 9.1. In EN 1991-1-4:2005-11, a general determination is made.

10.1.2 Earthquake

Buildings must be designed, calculated and constructed in an earthquake-proof fashion. The respective regulations are included in Eurocode 8.

Basically, earthquakes are horizontal and vertical vibrations of the building ground. From the analysis of characteristic earthquakes, earthquake spectrums with magnitudes and associated frequencies and amplitudes of acceleration during a quake can be stated.

Buildings are considered as a vibrating system, which is exposed to a forced vibration of the earthquake. From the earthquake spectrum, accelerations associated with the natural frequencies of the building can be determined. From these, forces as a consequence of the earthquake in the vertical and horizontal directions can be determined in turn by multiplication with the building masses.

Earthquakes represent an extraordinary design situation, in which the safety level may be lowered respectively. With respective regularity of the floor plans, the vertical loads additionally occurring due to the earthquake may thus be applied quasi-statically and are normally absorbed without additional structural measures. In case of higher buildings, however, the horizontally acting forces of mass inertia exceed the forces from wind – mostly from about three storeys upward. They must be verified by calculation and considered in construction.

In the present guideline, the complex subject of earthquakes can only be dealt with in a simplified and highly abridged manner. For more exact analyses, reference is made to the literature.¹

Earthquake-resistant design

The design with arrangement of bracing elements in the floor plan and building geometry in the elevation has substantial influence on the seismic performance of buildings. Mass concentrations at greater heights and elevations with free ground floor zones have an unfavourable effect. Favourable is the regular arrangement of bracing elements in the floor plan, which should continue equally across all storeys. Thereby, mass centre and centre of gravity of the element remain close to one another and twisting in the floor plan due to torsion is avoided. The seismic performance is also influenced by the choice and design of non-load-bearing elements.

Eurocode 8 states respective design specifications. Thus, structural simplicity, regularity, symmetry and redundancy, equal strength in both directions, the formation of diaphragms and sufficient foundation are substantial for earthquake-resistant construction. Storey-wise projections and recesses are not permitted for simplified earthquake verification.

The formation of a redundant structure is significant in order to be able to guarantee load-bearing reserves also upon failure of structural components. Failure of a structural element must not result in failure of other structural elements and must not propagate as a progressive collapse through large parts or the entirety of the building.

¹ BDZ (2011), Brunner et al. (2003), Giardini et al. (2012), Lignum (2010), Ringhofer und Schickhofer (2011), Sandhaas (2006), Walter und Fritzen (2008), and Walther und Wiesenkämpfer (2011).

Structural calculation

In Eurocode 8, the *simplified response spectrums method* is described for simplified calculations.¹ The earthquake is assumed as a static horizontal substitute load. Horizontal acceleration is determined from the earthquake spectrum for the first natural frequency. Higher natural frequencies are neglected.

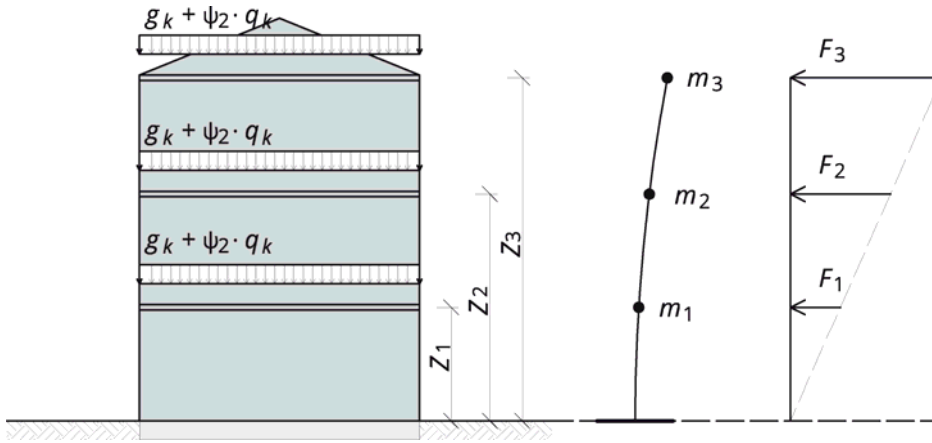

Figure 10-2: Substitute member with distribution of the substitute force across the building height

10.1.3 Calculation sequence

In the following, the calculation sequence is described very broadly. A more exact analysis considering Eurocode 8 is indispensable.

1. Location for ground acceleration

From the earthquake zone in the national Annex, the **ground acceleration on the ground** is determined: a_g

2. Underground conditions for earthquake spectrum

Depending on the subsoil class², the **parameters** S, TB, TC, TD³ used in Eurocode 8 for description of the **earthquake spectrum** are determined.

¹ EN 1998-1, Section 4.3.3.2.

² EN 1998-1, Table 3.1.

³ EN 1998-1, Section 3.2.2.5.

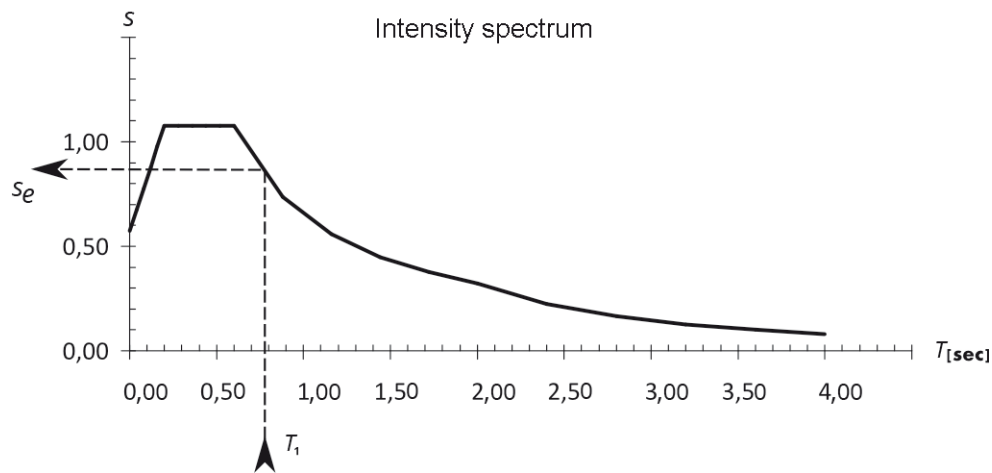

Figure 10-3: Example for an intensity spectrum (according to EN 1998)

3. Significance category and coefficient of significance

From the significance category of the object, the coefficient of significance γ is determined.

Table 10-1 Significance categories and coefficients of significance by type of building

Significance category	Buildings	γ
I	Agricultural buildings (low significance for public safety)	$\leq 1,00$ (frequently 0,80)
II	Residential buildings, office buildings and other "common buildings"	1,00
III	Schools, assemblies, cultural facilities (earthquake resistance is important)	$> 1,00$ (about 1,20)
IV	Hospitals, fire stations, power stations, etc. (intactness during an earthquake is of highest importance)	$> 1,00$ (about 1,40)

4. Mass determination per storey

For the building mass, the quasi-permanent portion of the live loads is considered.

$$m = g_k + \psi_2 \cdot n_k \quad (10.1)$$

The masses are applied at the height of the floors.

5. Basic duration of vibration

The basic duration of vibration T_1 is an important measure for earthquake calculation, since horizontal acceleration and thus the impacts on the structure depend on it.

The basic duration of vibration can be estimated from the following formula, which is based on the Rayleigh quotient:

$$T_1 = 2 \cdot \sqrt{u} \quad (10.2)$$

u Horizontal displacement of the upper edge of the building from the quasi-permanent vertical loads applied in the horizontal direction $q = g_k + \psi_2 \cdot n_k$.

6. Prerequisite for the simplified method

As a prerequisite for the simplified method, the requirements to regularity in floor plan and elevation according to EN 1998-1¹ must be complied with.

Furthermore, the minimum basic duration of vibration must be complied with:

$$T_1 \leq \begin{cases} 2 \text{ sec} \\ 4 \cdot T_c \end{cases} \quad (10.3)$$

T_c Parameter of the earthquake spectrum. Depending on the subsoil class, this is $T_c = 0,4 \div 0,8 \text{ sec}$.

7. Ductility class

Depending on the ductility class, the **coefficient of behaviour** q can be determined according to Table 10-2. For cross-laminated timber structures, $q = 1,50$ is recommended – with sufficiently ductile connections also $q = 2,00$. Analyses of cross-laminated timber for seismic stress have also already resulted in coefficients of behaviour of $q = 3,00$ and more.

Table 10-2 Ductility classes and maximums of the coefficients of behaviour¹

Low energy dissipation capacity	DCL	$q = 1,50$	Cantilever structures, girders, statically determined structures, frameworks with dowel connections [...]
Medium energy dissipation capacity	DCM	$q = 2,00$	Glued shear walls with glued areas of shear stress with nail or screw connections [...]
		$q = 2,50$	Statically over-determined frames with pin-type or bolt connections

¹ Section 4.2.3.2. for regularity in the floor plan and Section 4.2.3.3. in the elevation.

8. Horizontal acceleration

The horizontal acceleration for T_1 can be read from the spectrum and then is

$$a_{hor} = \frac{S_e(T)}{q} \quad (10.4)$$

On the safe side, here, the plateau value of the spectrum may also be used.

$$a_{hor} = 2,5 \cdot a_g \cdot \frac{S}{q} \quad (10.5)$$

9. Earthquake forces per storey

The earthquake forces are weighted linearly to the height above ground.

$$F_{d,i} = \frac{z_i \cdot m_i}{\sum z_i \cdot m_i} \cdot F_d \quad (10.6)$$

$$F_d = \sum m_i \cdot a_{hor} \quad (10.7)$$

A random torsional effect of 5 % of the storey dimension b must be considered.

$$M_d = 0,05 \cdot b \cdot F_d \quad (10.8)$$

10.1.4 Misalignment

The building's deflection of the plumb line is normally applied with

$$\varphi = \frac{1}{200}^1 \quad (10.9)$$

The horizontal load from misalignment then results in:

$$H = \varphi \cdot V \quad (10.10)$$

10.2 Stability

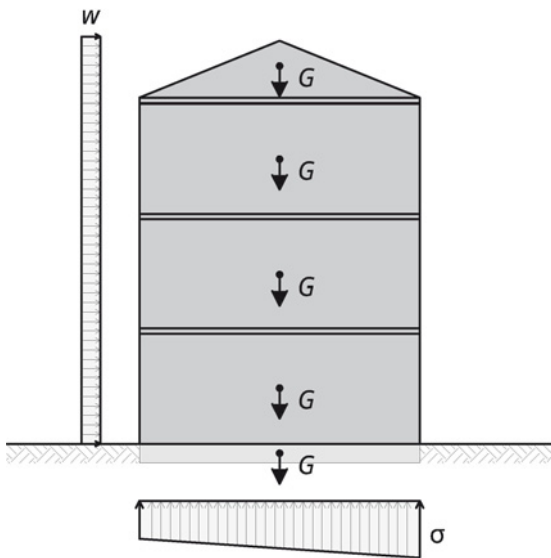

Figure 10-4: Impacts and distribution of the contact pressure

Further stability verifications are tilting of the object for tower-type buildings and ground seepage or sliding, respectively, in case of bad foundation conditions.

10.3 Force progression

For the earthquake condition, it is required that shear walls are arranged regularly in the floor plan and continuously in the elevation. Otherwise, it applies to horizontal load distribution that the loads accumulate storey-wise (Figure 10-5) and may be considered in an isolated fashion for each storey. Prerequisite for that are a stiff diaphragm and bracing walls along at least three – better four – axes. The bracing wall axes must not have a common intersection and must not be parallel to one another. For bracing, interior and exterior walls may be included.

¹ In EN 1995-1-1, Section 5.4.4., this misalignment is suggested for the analysis of frames and arches according to the second order theory.

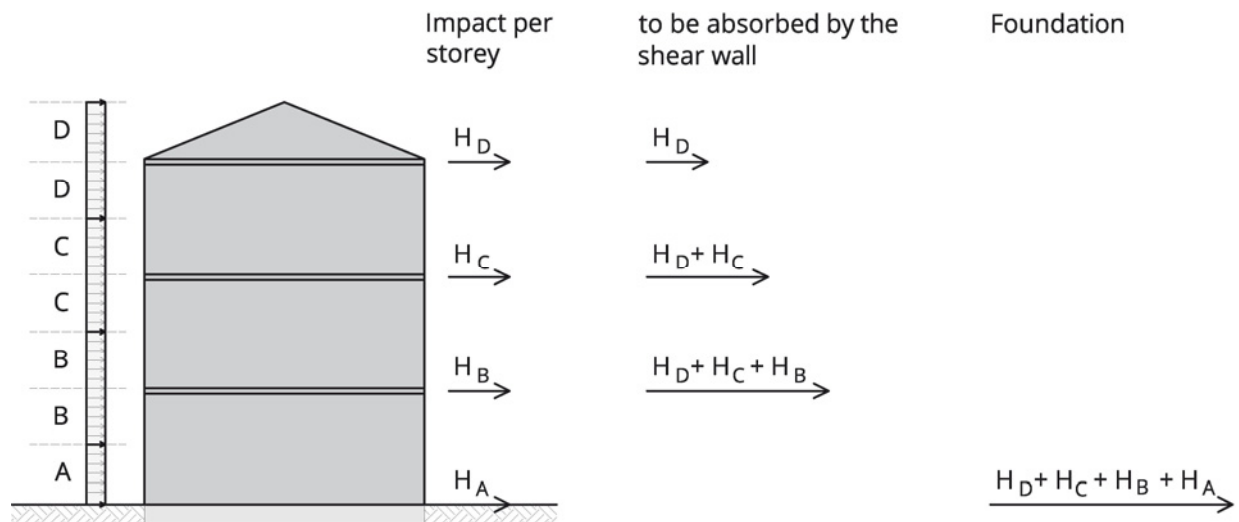

Figure 10-5: Horizontal forces per storey resulting from wind pressure with stress on the shear walls in the individual storeys

The impacts accumulate from top to bottom. The force per storey is determined at ceiling level and for the topmost storey results from the incident flow area of the roof and half the storey height below (letters D in Figure 10-5), and for the storeys below respectively from half the storey height above and below (letters A to C in Figure 10-5).

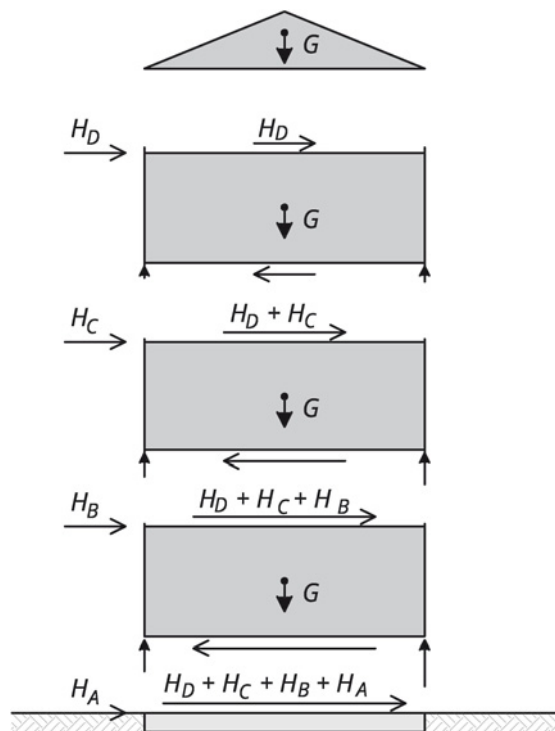

Figure 10-6: Force progression per storey with vertical loads

The forces per storey are shown in Figure 10-6.

In the horizontal connection joints at the ground, the horizontal impacts at ceiling level result in tensile forces on one side of the building and in compressive forces on the other side. These compressive forces are normally small compared to those from the permanent superimposed loads. The tensile forces are subordinate to those forces resulting from the individual shear walls being set on edge. Therefore, the building's bending and forces resulting therefrom may be neglected most of the time. For slender and tower-like buildings, however, they must be considered.

10.4 Diaphragms

According to 10.3., diaphragms are a prerequisite for the bracing of buildings. Diaphragms result from the joining of adjacent ceiling elements along their common joints into a plate, as shown in Figure 11-5. A continuous diaphragm is necessary to distribute the horizontal loads to the walls below and to further transfer them into the storey below.

Openings in diaphragms are normally unproblematic and require simple structural measures.

Diaphragm with bracing walls
and wind impact

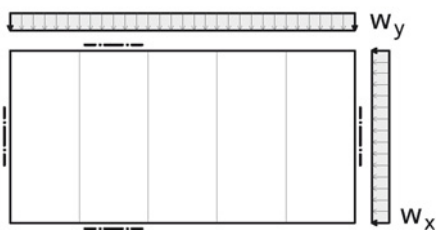
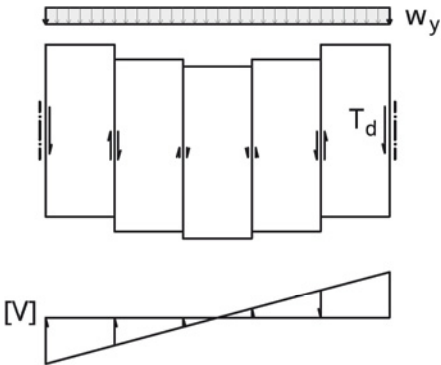

Figure 10-7: Floor plan of a ceiling span with bracing shear walls and wind impact

The possible failure mechanisms of diaphragms are shown in Figure 10-8. Impacts in the direction of the longitudinal joints result in a) shear forces and b) flange forces. The shear forces in the joints must be covered via respective fasteners according to Figures 9-7a) and b) (page 100). Since the horizontal impacts normally act in both directions, the flange forces likewise have to be considered with alternating signs. They occur as a pair of forces of pressure and tension at the joint edges. The tension flange forces can be applied into the lintel beams and wall elements below via screw connections and transferred by these. Should structural elements below be missing or should these not be continuous, then suitable fasteners according to Figures 9-7c) and d) (page 100) must be used.

Impacts transverse to the joints result in c) bending of the elements as horizontal girders. Normally, these are not relevant for calculation. The connection forces to the shear walls must be transferred with respective fasteners.

a) Shear along the joints



b) Flange forces at the plate edge

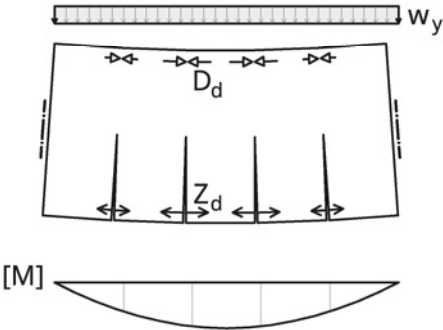

c) Stress on the plate as a horizontal girder

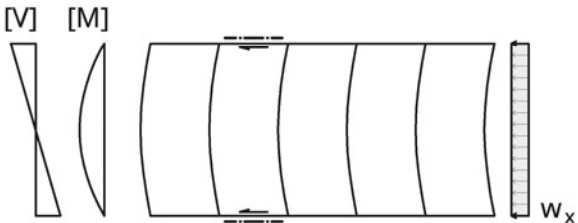

Figure 10-8: Failure mechanisms of diaphragms

10.5 Shear walls

10.5.1 Arrangement of shear walls

In 10.3., the basic requirements to bracing shear walls were described. Figure 10-9 shows suitable arrangements of shear walls. Favourable is the position of the plate's centre of gravity in the centre of the floor plan, if possible, since thus twisting of the building about its axis is avoided. Figure 10-10 shows unsuitable arrangements due to the eccentric position of the centre of gravity, and Figure 10-11 shows instable arrangements.

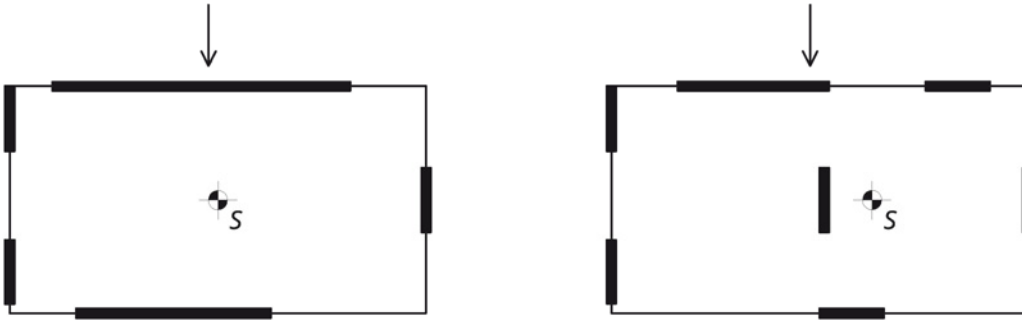

Figure 10-9: Suitable arrangement of shear walls

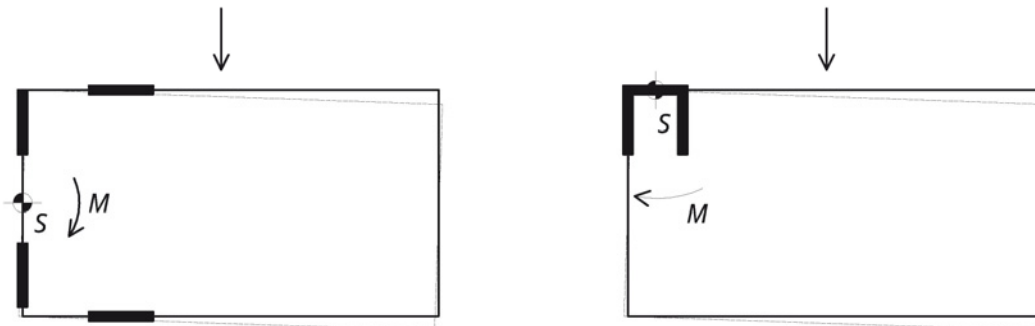

Figure 10-10: Unsuitable arrangement of shear walls

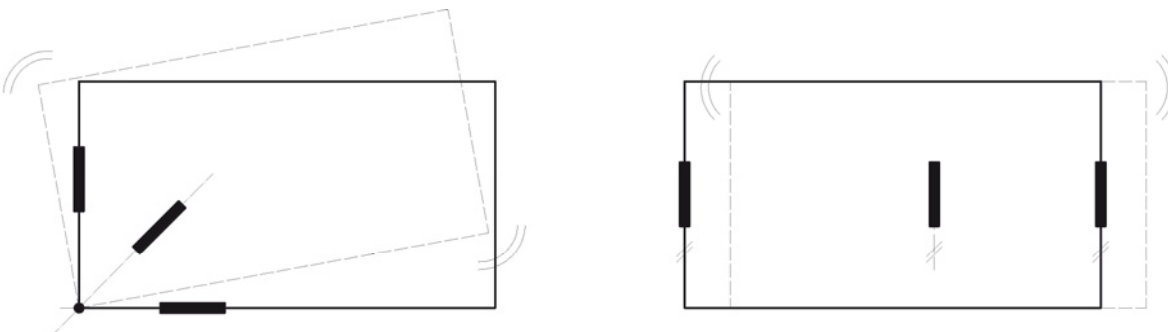

Figure 10-11: Instable arrangement of shear walls

10.5.2 Distribution of impact to the plates

For verification of shear walls and design of suitable fasteners of individual plates in the floor plan, the horizontal force H , acting at the storey's top edge, must be distributed to the individual plates.

If the floors are sufficiently stiff, the force can be distributed to the individual shear walls according to their respective stiffness. In case of soft diaphragms, the wall stiffnesses lose influence, since the forces cannot be passed on up to the stiffer load-bearing walls.

The stiffness B of the shear walls can be generally determined according to 10.5.3, depending on the joining technique. Comparative calculations with tie rods and shear brackets resulted in about $B \sim \ell^{1.5}$, for continuously joined joints up to $B \sim \ell^2$. In a first approximation, the stiffness of the plates is frequently assumed proportional to their respective length. With this assumption, for short plates, too high stiffnesses and thus larger forces result, and for longer plates slightly lower forces.

In the present guideline, $B \sim \ell^{1.5}$ is recommended for cross-laminated timber walls.

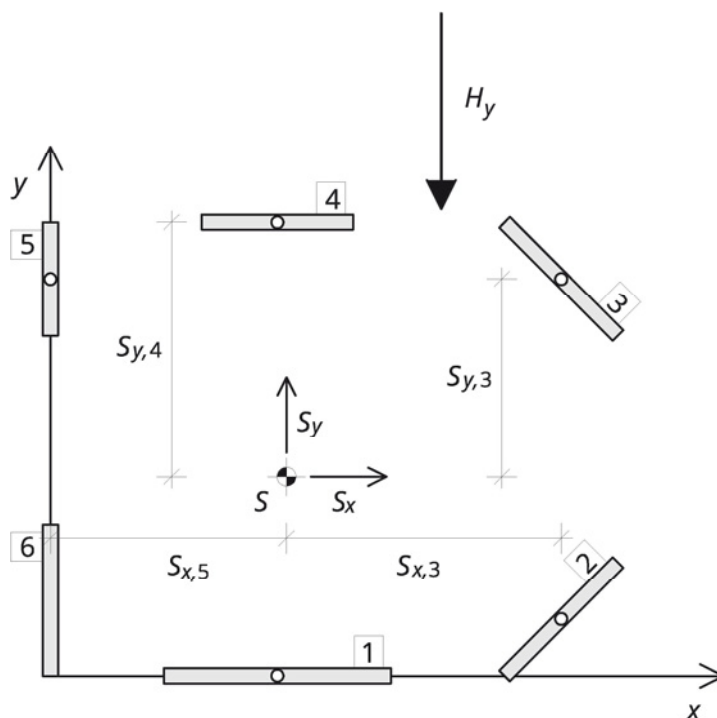

Figure 10-12: Axis designations and dimensions for a building floor plan

Determination of the plate forces may take place according to the following steps:

1. Determination of geometry and stiffness of the individual plate

Plate stiffness:

With assumption $B \sim \ell^{1,5}$:

$$B_{x,i} = \ell^{1,5} = |x_E - x_A|^{1,5} \quad (10.11)$$

$$B_{y,i} = \ell^{1,5} = |y_E - y_A|^{1,5} \quad (10.12)$$

Plate centre:

$$x_i = \frac{x_A + x_E}{2} \quad (10.13)$$

$$y_i = \frac{y_A + y_E}{2} \quad (10.14)$$

2. Determination of the position of the centre of gravity

$$x_S = \frac{\sum B_{y,i} \cdot x_i}{\sum B_{y,i}} \quad (10.15)$$

$$y_S = \frac{\sum B_{x,i} \cdot y_i}{\sum B_{x,i}} \quad (10.16)$$

3. Determination of the moment from eccentricity of the impact forces to the centre of gravity

$$M = H_x \cdot (y_H - y_S) + H_y \cdot (x_H - x_S) \quad (10.17)$$

4. Calculation of the distribution of impacts on the individual shear walls

$$I_p = \sum B_{x,i} \cdot s_y^2 + \sum B_{y,i} \cdot s_x^2 \quad (10.18)$$

$$F_{x,i} = H_x \cdot \frac{B_{x,i}}{\sum B_{x,i}} + M \cdot \frac{s_y \cdot B_{x,i}}{I_p} \quad (10.19)$$

$$F_{y,i} = H_y \cdot \frac{B_{y,i}}{\sum B_{y,i}} + M \cdot \frac{s_x \cdot B_{y,i}}{I_p} \quad (10.20)$$

Figure 10-13 shows, as an example, the reaction forces of the plate as a consequence of a force H_y in the centre of gravity, on the one hand, and with eccentricity to the centre of gravity, on the other hand.

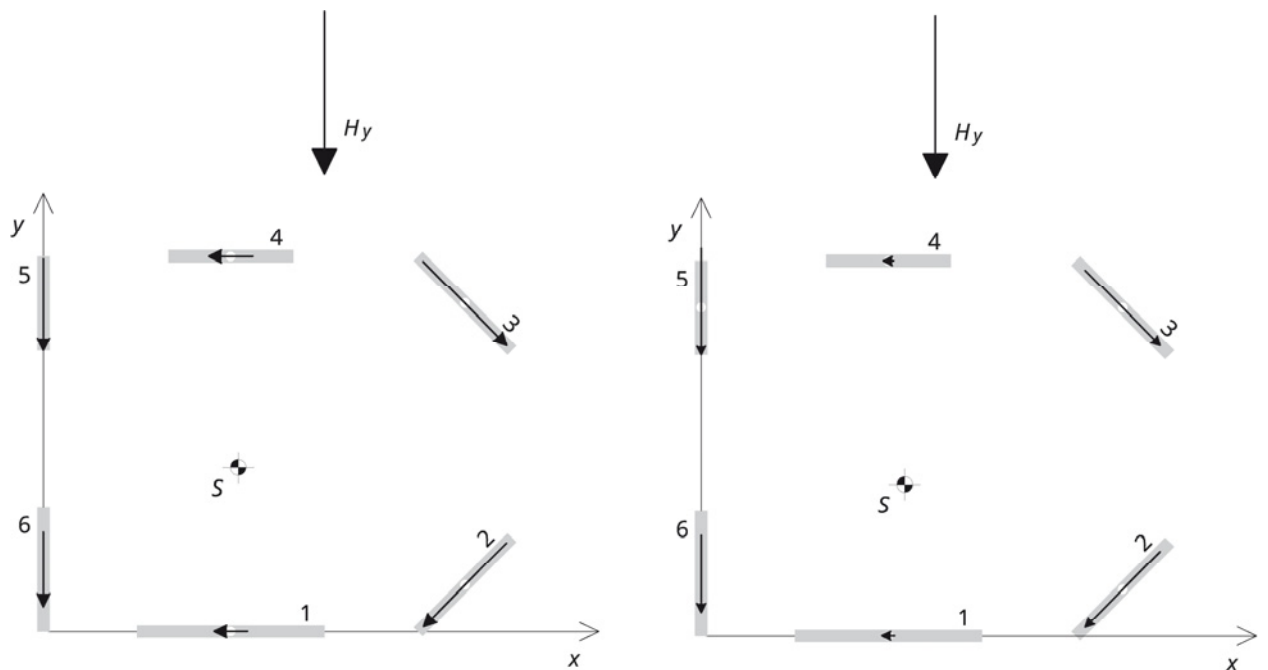

Figure 10-13: Reaction forces in the plates

10.5.3 Deformation and stiffness

The deformation of shear walls must at least be limited with $1/300$ of the storey height¹ – compliance with $1/500$ of the height is recommended. In the following, the individual portions of overall deformation are estimated. Due to the relatively high plate stiffness of cross-laminated timber, the deformation portions of the fasteners are normally dominant.

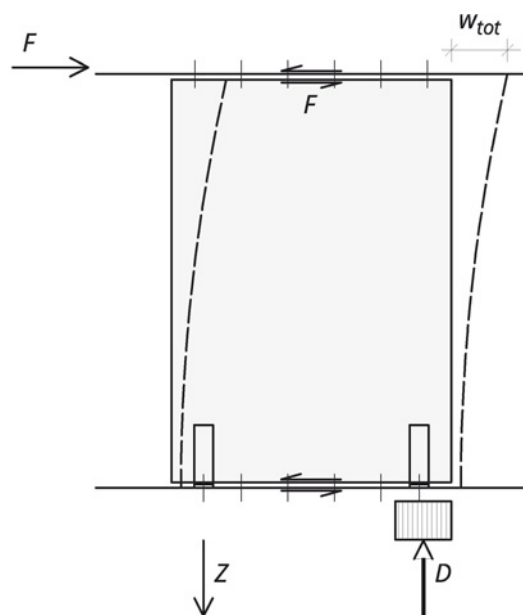

Figure 10-14: Shear wall with connection to ceiling and floor

¹ ÖNORM B 1990-1, Section 4.2.2.

Bending deformation of the shear wall [mm]

$$w_M = \frac{F_k \cdot h^3}{3 \cdot EI} \cdot 10^{-4} \quad (10.21)$$

Shear deformation of the shear wall [mm]

$$w_V = \frac{F_k \cdot h}{GA_s} \quad (10.22)$$

Expansion of the tie rods [mm]

$$w_Z = \frac{F_k \cdot h^2}{b^2 \cdot c_Z} \quad (10.23)$$

Displacement in one of the two joints between wall and ceiling [mm]

$$w_F = \frac{F_k}{c_F} \quad (10.24)$$

h Height of the shear wall [m]

b Length of the shear wall [m]

EI Flexural stiffness [kNm²]

$$E = E_{0,mean}$$

$$I = \frac{d_{0,net} \cdot b^3}{12}$$

GA_s Shear stiffness [kN]

$$G \approx 0,75 \cdot G_{0,mean}$$

$$A = d_{gross} \cdot b$$

F_k Horizontal force at the plate head in the characteristic design situation [kN]

c_F Stiffness of the wall-ceiling joint [kN/mm]

c_Z Stiffness of the fasteners for tensile anchoring [kN/mm]

Upon assumption of about equal joint stiffness at the top and at the bottom, the overall deformation results as follows

$$w_{hor} = w_M + w_V + w_Z + 2 \cdot w_F \quad (10.25)$$

10.5.4 Verifications

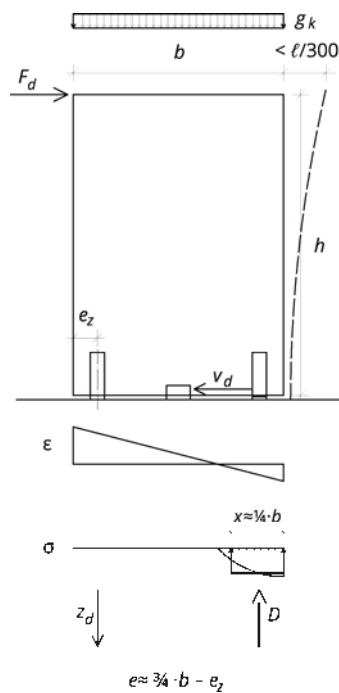

Figure 10-15: Dimensions of a shear wall

Shear stress of the plate

Basically, the verifications stated in 5.8 must be undertaken, even though they become decisive for very slender walls only.

Tension anchoring

It must be verified that the resistance of the selected fasteners is higher than the impact.

$$Z_d \leq F_{R,1,d} \tag{10.26}$$

The tensile force results as follows:

$$Z_d = \frac{F_d \cdot h}{e} - 0,9 \cdot G_{Z,k} \dots\dots\dots \text{Tensile force} \tag{10.27}$$

e Inner lever

$G_{Z,k}$ Portion from permanent impacts with a possibly relieving effect

Constant distribution of the stresses in the contact area is assumed. Analogous to steel construction, a model with the width of the pressure zone of $x = \frac{1}{4} \cdot b$ is used. Accordingly, the inner lever results as follows:

$$e = \frac{3}{4} \cdot b - e_z \tag{10.28}$$

Upon determination of the tensile forces of the anchoring, the tensile forces resulting from bending of the entire building may normally remain unconsidered on the building's side facing the wind. This must only be considered for slender, tower-type buildings.

The tensile force to be anchored is reduced with permanent superimposed loads. As a relieving portion, they may only be applied with 90 %.

In multi-storey buildings, better load distribution to the walls can be achieved by stressing the ceilings storey-wise in different directions.

Upon distribution of the tie rods, the alternating signs of wind impact and consequently the arrangement at both ends of the respective shear wall must be observed.

Shear anchoring

$$V_d \leq F_{R,2,d} \quad (10.29)$$

$$V_d = F_d - 0,9 \cdot \mu \cdot G_{V,k} \quad \text{..... Shear force in the joint} \quad (10.30)$$

$\mu \cdot G_{V,k}$ Portion of friction from permanent impacts with a relieving effect.

Upon joint formation with a film, friction may be applied, however, not, if there are two films on top of one another.

$$\mu \approx 0,2 \div \underline{0,4} \div 0,5 \quad \text{..... Sliding friction timber-timber}^1$$

$$\mu \approx 0,4 \quad \text{..... Sliding friction timber-concrete}$$

Serviceability

For the characteristic design situation, the horizontal displacement at the wall head has to be limited as follows (recommended value according to Section 10.5.3):

$$w_{hor} \leq \frac{h}{500} \quad (10.31)$$

¹ VDI 2700:2002.

11 Application examples

The authors are planning to discuss applications on the website www.xlam.info and to list further examples and suggestions on the subject of cross-laminated timber there.

11.1 Basic principles

11.1.1 X-LAM cross-section with five layers

Given: X-LAM element X-LAM 160 L5s
Build-up: 40l – 20w – 40l – 20w – 40l
BSP 160 L5s

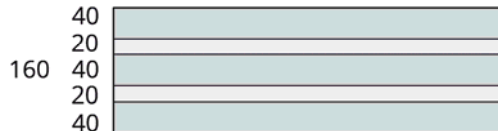

Strength class of all board layers: C24

Characteristic material values:

Modulus of elasticity $E_{0,mean} = 11.000 \text{ N/mm}^2$

Rolling shear modulus $G_{R,mean} = 50 \text{ N/mm}^2$

Reference length for calculation according to the Gamma method $l_{ref} = 4,5 \text{ m}$

Sought: Cross-sectional values for load-bearing capacity and serviceability.

Cross-sectional values for load-bearing capacity

Position of the centre of gravity

Symmetrical cross-section

$$z_s = \frac{h}{2}$$

$$\underline{z_s} = \frac{160}{2} = \underline{80 \text{ mm}}$$

Area

$$A_{0,net} = \sum_{i=1}^n \frac{E_i}{E_c} \cdot b \cdot d_i$$

Formula (4.3)

The E moduli are equal for all layers $\Rightarrow \frac{E_i}{E_n} = 1$

$$\underline{A_{0,net}} = 100 \cdot (4 + 4 + 4) = \underline{1.200 \text{ cm}^2}$$

Moment of inertia (net value – rigid)

$$I_{0,net} = \sum_{i=1}^n \frac{E_i}{E_c} \cdot \frac{b \cdot d_i^3}{12} + \sum_{i=1}^n \frac{E_i}{E_c} \cdot b \cdot d_i \cdot a_i^2$$

Formula (4.5)

Distances of axes

$$a_1 = \left(\frac{d_1}{2} + d_{1,2} + \frac{d_2}{2} \right) - a_2$$

$$a_1 = \frac{40}{2} + 20 + \frac{40}{2} = 60 \text{ mm}$$

Symmetrical cross-section

$$a_2 = 0 \text{ mm}$$

$$a_3 = a_1 = 60 \text{ mm}$$

$$I_{0,net} = 3 \cdot \left(\frac{100 \cdot 4^3}{12} \right) + 2 \cdot (100 \cdot 4 \cdot 6^2)$$

$$\underline{I_{0,net}} = 1.600 + 28.800 = \underline{30.400 \text{ cm}^4}$$

Section modulus

$$W_{net} = \frac{I_{net}}{\max\{z_o; z_u\}}$$

$$z_o = z_u = z_s = 80 \text{ mm}$$

$$\underline{W_{net}} = \frac{30.400}{8} = \underline{3.800 \text{ cm}^3}$$

Formula (4.4)

Static moment (rolling shear)

$$S_{R,net} = \sum_{i=1}^R \frac{E_i}{E_c} \cdot b \cdot d_i \cdot a_i$$

$$\underline{S_{R,net}} = 100 \cdot 4 \cdot 6 = \underline{2.400 \text{ cm}^3}$$

Formula (4.7)

Cross-sectional values for serviceability

Moment of inertia (effective value - shear-flexible)

$$I_{0,ef} = \sum_{i=1}^n \frac{b \cdot d_i^3}{12} + \sum_{i=1}^n \gamma_i \cdot \frac{E_i}{E_c} \cdot b \cdot d_i \cdot a_i^2$$

Formula (4.25)

Distances of axes

Symmetrical cross-section:

$$a_2 = 0$$

$$a_1 = \left(\frac{d_1}{2} + d_{1,2} + \frac{d_2}{2} \right) - a_2$$

$$a_1 = \left(\frac{40}{2} + 20 + \frac{40}{2} \right) - 0 = 60 \text{ mm}$$

$$a_3 = a_1 = 60 \text{ mm}$$

Gamma factors

$$\gamma_1 = \frac{1}{\left(1 + \frac{\pi^2 \cdot E_1 \cdot b \cdot d_1 \cdot d_{1,2}}{\ell_{ref}^2 \cdot b \cdot G_{R,1,2}} \right)}$$

Formula (4.20)

$$y_1 = \frac{1}{\left(1 + \frac{\pi^2 \cdot 11.000 \cdot 1.000 \cdot 40}{4.500^2} \cdot \frac{20}{1.000 \cdot 50}\right)} = 0,921$$

Symmetrical cross-section:

$$y_3 = y_1 = 0,92$$

$$I_{0,ef} = 3 \cdot \left(\frac{100 \cdot 4^3}{12}\right) + 2 \cdot (0,921 \cdot 100 \cdot 4 \cdot 6^2)$$

$$I_{0,ef} = 1.600 + 26.525 = \underline{28.125 \text{ cm}^4}$$

11.1.2 X-Lam cross-section with five layers - transverse to the main direction of load-bearing capacity

Given: X-LAM element X-Lam 160 L5s

Build-up: 40l - 20w - 40l - 20w - 40l

BSP 160 L5s

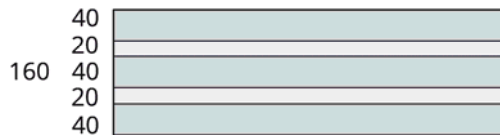

Strength class **of all board layers: C24**

Characteristic material values:

Modulus of elasticity $E_{0,mean} = 11.000 \text{ N/mm}^2$

Rolling shear modulus $G_{R,mean} = 50 \text{ N/mm}^2$

Reference length **for calculation according to the Gamma method** $l_{ref} = 4,5 \text{ m}$

Sought: Cross-sectional values for load-bearing capacity and serviceability upon bending in the **ancillary direction of load-bearing capacity** (transverse to the main direction of load-bearing capacity)

Cross-sectional values for load-bearing capacity

Position of the centre of gravity

Symmetrical cross-section

$$z_s = \frac{h}{2}$$

$$z_s = \frac{160}{2} = \underline{80 \text{ mm}}$$

Area

$$A_{g0,net} = \sum_{i=1}^n \frac{E_i}{E_c} \cdot b \cdot d_i$$

The E moduli are equal for all layers $\Rightarrow \frac{E_i}{E_c} = 1$

$$A_{g0,net} = 100 \cdot (2 + 2) = \underline{400 \text{ cm}^2}$$

Formula (4.3)
in transverse
direction

Moment of inertia (net value - rigid)

$$I_{90,net} = \sum_{i=1}^n \frac{E_i}{E_c} \cdot \frac{b \cdot d_i^3}{12} + \sum_{i=1}^n \frac{E_i}{E_c} \cdot b \cdot d_i \cdot a_i^2$$

Formula (4.5)

in transverse direction

Distances of axes

Symmetrical cross-section

$$a_1 = 30 \text{ mm}; a_2 = 30 \text{ mm}$$

$$I_{90,net} = 2 \cdot \left(\frac{100 \cdot 2^3}{12} \right) + 2 \cdot (100 \cdot 2 \cdot 3^2)$$

$$I_{90,net} = 133,33 + 3.600 = \underline{3.733 \text{ cm}^4}$$

Section modulus

$$W_{90,net} = \frac{I_{90,net}}{\max\{z_o; z_u\}}$$

$$z_o = z_u = z_s = 40 \text{ mm}$$

$$W_{90,net} = \frac{3.733}{4} = \underline{933 \text{ cm}^3}$$

Formula (4.4)

in transverse direction

Static moment (rolling shear)

$$S_{90,R,net} = \sum_{i=1}^R \frac{E_i}{E_c} \cdot b \cdot d_i \cdot a_i$$

$$S_{90,R,net} = 100 \cdot 2 \cdot 3 = \underline{600 \text{ cm}^3}$$

Formula (4.7)

in transverse direction

Cross-sectional values for serviceability

Moment of inertia (effective value - shear-flexible)

$$I_{90,ef} = \sum_{i=1}^n \frac{b \cdot d_i^3}{12} + \sum_{i=1}^n \gamma_i \cdot \frac{E_i}{E_c} \cdot b \cdot d_i \cdot a_i^2$$

Formula (4.25)

in transverse direction

Distances of axes

Symmetrical cross-section:

$$a_1 = \frac{d_1}{2} + \frac{d_{1,2}}{2}$$

$$a_1 = \frac{20}{2} + \frac{40}{2} = 30 \text{ mm}$$

$$a_3 = a_1 = 30 \text{ mm}$$

Gamma factors

$$\gamma_1 = \frac{1}{\left(1 + \frac{\pi^2 \cdot E_1 \cdot b \cdot d_1}{\ell_{ref}^2} \cdot \frac{d_{1,2}}{b \cdot G_{R,12}} \right)}$$

$$y_1 = \frac{1}{\left(1 + \frac{\pi^2 \cdot 11.000 \cdot 1.000 \cdot 40}{4.500^2} \cdot \frac{20}{1.000 \cdot 50}\right)} = 0,921$$

Symmetrical cross-section:

$$y_2 = y_1 = 0,92$$

$$I_{90,ef} = 2 \cdot \left(\frac{100 \cdot 2^3}{12}\right) + 2 \cdot (0,921 \cdot 100 \cdot 2 \cdot 3^2)$$

$$I_{90,ef} = 133,33 + 3.315,6 = \underline{3.449 \text{ cm}^4}$$

11.1.3 X-LAM cross-section with timber-based material as the load-bearing layer

Given: X-Lam element X-Lam 160 L5s with a statically effective glued bottom layer of laminated veneer lumber (LVL) 27 mm

BSP 160 L5s + FSH 27



Build-up: 40l – 20w – 40l – 20w – 40l – LVL27l

Strength class of all board layers: C24

Characteristic material values:

Modulus of elasticity $E_{0,mean} = 11.000 \text{ N/mm}^2$

Rolling shear modulus $G_{R,mean} = 50 \text{ N/mm}^2$

Characteristic material values of the layers of laminated veneer lumber

Modulus of elasticity $E_{0,mean} = 10.500 \text{ N/mm}^2$

Reference length for calculation according to the Gamma method $l_{ref} = 4,5 \text{ m}$

Sought: Cross-sectional values for load-bearing capacity and serviceability

Cross-sectional values for load-bearing capacity

BSP 160 L5s + FSH 27

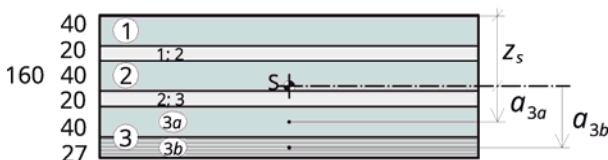

Position of the centre of gravity

Formula (4.1)

$$z_s = \frac{\sum_{i=1}^n \frac{E_i}{E_c} \cdot A_i \cdot o_i}{\sum_{i=1}^n \frac{E_i}{E_c} \cdot A_i}$$

Tabular calculation:

<i>i</i>	<i>b</i>	$\frac{E_i}{E_c}$	<i>d_i</i>	$\frac{E_i}{E_c} \cdot A_i$	<i>o_i</i>	$\frac{E_i}{E_c} \cdot A_i \cdot o_i$
$= b \cdot d_i$						
	[cm]	[-]	[cm]	[cm ²]	[cm]	[cm ³]
1	100	1,000	4,0	400,00	2,00	800
2	100	1,000	4,0	400,00	8,00	3.200
3a	100	1,000	4,0	400,00	14,00	5.600
3b	100	0,955	2,7	257,85	17,35	4.474
Sum				1.457,85		14.074

$$z_s = \frac{14.074}{1.457,85} = 9,66 \text{ cm}$$

Moment of inertia (net value - rigid)

Formula (4.5)

$$I_{net} = \sum_{i=1}^n \frac{E_i}{E_c} \cdot \frac{b \cdot d_i^3}{12} + \sum_{i=1}^n \frac{E_i}{E_c} \cdot b \cdot d_i \cdot a_i^2$$

Tabular calculation:

<i>i</i>	$\frac{E_i}{E_c} \cdot A_i$	<i>a_i</i>	<i>I_{intrinsic}</i>	$\frac{E_i}{E_c} \cdot A_i \cdot a_i^2$
$= o_i - z_s$			$= \frac{b \cdot d_i^3}{12}$	
	[cm ²]	[cm]	[cm ⁴]	[cm ⁴]
1	400,00	- 7,65	533,33	23.409
2	400,00	- 1,65	533,33	1.089
3a	400,00	4,35	533,33	7.569
3b	257,85	7,70	157,64	15.288
Sum	1.457,85		1.757	47.355

$$I_{net} = 1.757 + 47.355 = 49.112 \text{ cm}^4$$

Section moduli

Formula (4.4)

$$W_{net,i} = \frac{I_{net}}{z_i}$$

Top edge fibre of the X-Lam element

$$z_{clt,o} = a_1 - \frac{d_1}{2} = -7,65 - \frac{4}{2} = -9,65 \text{ cm}$$

$$W_{net,clt,o} = \frac{49.112}{-9,65} = -5.089 \text{ cm}^3$$

Bottom edge fibre of the X-Lam element

$$z_{ct,u} = a_{3a} + \frac{d_{3a}}{2} = 4,35 + \frac{4}{2} = 6,35 \text{ cm}$$

$$W_{net,ct,u} = \frac{49.112}{6,35} = 7.734 \text{ cm}^3$$

Bottom edge fibre of the LVL layer

$$z_{lv,u} = a_{3b} + \frac{d_{3b}}{2} = 7,7 + \frac{2,7}{2} = 9,05 \text{ cm}$$

$$W_{net,lv,u} = \frac{49.112}{9,05} = 5.682 \text{ cm}^3$$

Stress determination for the LVL layer considering the E modulus:

$$\sigma_{lv,u} = \frac{E_f}{E_c} \cdot \frac{M}{W_{net,lv,u}}$$

σ

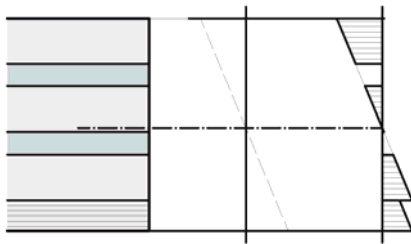

Static moment (rolling shear)

$$S_{R,net} = \sum_{i=1}^R \frac{E_i}{E_c} \cdot A_i \cdot |a_i|$$

$$S_{R,net} = A_1 \cdot |a_1| + A_2 \cdot |a_2|$$

$$S_{R,net} = 400 \cdot 7,65 + 400 \cdot 1,65 = 3.722 \text{ cm}^3$$

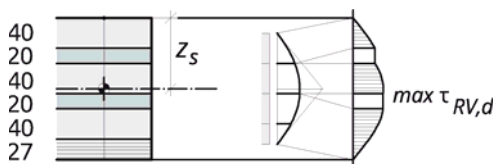

Formula (4.7)

Cross-sectional values for serviceability

Moment of inertia (effective value - shear-flexible)

$$I_{ef} = \sum_{i=1}^n I_{eigen,i} + \sum_{i=1}^n \gamma_i \cdot A_i \cdot a_i^2$$

Formula (4.25)

in transverse direction

BSP 160 L5s + FSH 27



Part 3: The adjacent layers with the same orientation 3a and 3b are considered as one layer.

Sub-area 3

$$A_3 = \frac{E_{3a}}{E_c} \cdot A_{3a} + \frac{E_{3b}}{E_c} \cdot A_{3b}$$

$$A_3 = 1 \cdot 400 + \frac{10.500}{11.000} \cdot 270 = 657,73 \text{ cm}^2$$

Distance of axes part 3

$$a_3 = \frac{\frac{E_{3a}}{E_c} \cdot A_{3a} \cdot a_{3a} + \frac{E_{3b}}{E_c} \cdot A_{3b} \cdot a_{3b}}{A_3}$$

$$a_3 = \frac{1 \cdot 400 \cdot 4,35 + \frac{10.500}{11.000} \cdot 270 \cdot 7,7}{657,73} = 5,66 \text{ cm}$$

Intrinsic moment of inertia part 3

$$I_{eigen,3} = \frac{E_{3a}}{E_c} \cdot \left[\frac{b \cdot d_{3a}^3}{12} + A_{3a} \cdot (a_{3a} - a_3)^2 \right] + \frac{E_{3b}}{E_c} \cdot \left[\frac{b \cdot d_{3b}^3}{12} + A_{3b} \cdot (a_{3b} - a_3)^2 \right]$$

$$I_{eigen,3} = 1 \cdot \left[\frac{100 \cdot 4^3}{12} + 400 \cdot (4,35 - 5,66)^2 \right] + \frac{10.500}{11.000} \cdot \left[\frac{100 \cdot 2,7^3}{12} + 270 \cdot (7,70 - 5,66)^2 \right]$$

$$I_{eigen,3} = 533,33 + 686,44 + 0,955 \cdot [164,03 + 1.123,6] = 1.219,8 + 1.229,7 = 2.449 \text{ cm}^4$$

Gamma factors

$$\gamma_1 = \frac{1}{\left(1 + \frac{\pi^2 \cdot E_1 \cdot b \cdot d_1}{\ell_{ref}^2} \cdot \frac{d_{1,2}}{b \cdot G_{R,12}} \right)}$$

$$\gamma_1 = \frac{1}{\left(1 + \frac{\pi^2 \cdot 11.000 \cdot 1.000 \cdot 40}{4.500^2} \cdot \frac{20}{1.000 \cdot 50} \right)} = 0,921$$

$$\gamma_2 = 1$$

Formula (4.20)
cont.

$$Y_3 = \frac{1}{\left(1 + \frac{\pi^2 \cdot E_n \cdot A_3}{I_{ref}^2} \cdot \frac{d_{2,3}}{b \cdot G_R}\right)}$$

$$Y_3 = \frac{1}{\left(1 + \frac{\pi^2 \cdot 11.000 \cdot (400 + 257,73)}{4.500^2} \cdot \frac{20}{1.000 \cdot 50}\right)} = 0,876$$

$$I_{ef} = \sum_{i=1}^n I_{eigen,i} + \sum_{i=1}^n Y_i \cdot A_i \cdot a_i^2$$

$$I_{ef} = 533,33 + 533,33 + 2.449,5 + 0,921 \cdot 400 \cdot 7,65^2 + 1 \cdot 400 \cdot 1,65^2 + 0,876 \cdot 657,85 \cdot 5,66^2$$

$$\underline{I_{ef}} = 3.516,2 + 21.559,7 + 1.089 + 18.461,4 = \underline{44.626 \text{ cm}^4}$$

Formula (4.25)

11.1.4 Cross-section following charring

Given: X-LAM element X-LAM 160 L5s
Build-up: 40l – 20w – 40l – 20w – 40l

BSP 160 L5s

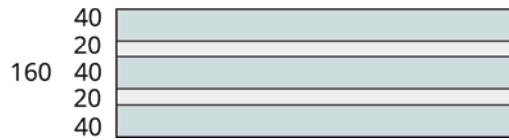

Strength class of all board layers: C24

Characteristic material values:

Modulus of elasticity $E_{0,mean} = 11.000 \text{ N/mm}^2$

Rolling shear modulus $G_{R,mean} = 50 \text{ N/mm}^2$

Assumed fire performance: consistent charring for all layers.

Charring rate $\beta_0 = 0,65 \text{ mm/min}$

required fire resistance R30 (unilateral from the bottom)

Sought: Cross-sectional values for verification of load-bearing capacity in the event of fire

Residual cross-section

Effective charring depth

$$d_{ef} = d_{char} + k_0 d_0$$

Charring rate

$$d_{char} = \beta_0 \cdot d_0$$

$$d_{char} = 0,65 \cdot 30 = 19,5 \text{ mm}$$

Pyrolysis zone

$$k_0 d_0 = 7 \text{ mm}$$

$$\underline{d_{ef} = 19,5 + 7 = 26,5 \text{ mm}}$$

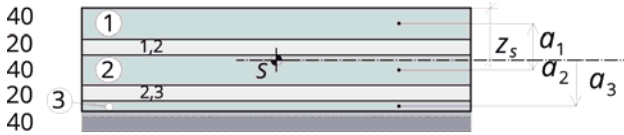
Cross-sectional values for load-bearing capacity in the event of fire

Position of the centre of gravity

$$z_s = \frac{\sum_{i=1}^n \frac{E_i}{E_c} \cdot A_i \cdot o_i}{\sum_{i=1}^n \frac{E_i}{E_c} \cdot A_i}$$

Formula (4.1)

Tabular calculation:

i	b	$\frac{E_i}{E_c}$	d_i	$\frac{E_i}{E_c} \cdot A_i$	o_i	$\frac{E_i}{E_c} \cdot A_i \cdot o_i$
				$= b \cdot d_i$		
	[cm]	[-]	[cm]	[cm ²]	[cm]	[cm ³]
1	100	1,000	4,00	400,00	2,000	800,0
2	100	1,000	4,00	400,00	8,000	3.200,0
3	100	1,000	1,35	135,00	12,675	1.711,1
Sum				935,00		5.711,1

$$\underline{z_s} = \frac{5.711,1}{935} = \underline{6,108 \text{ cm}}$$

Moment of inertia (net value - rigid)

$$I_{net} = \sum_{i=1}^n \frac{E_i}{E_c} \cdot \frac{b \cdot d_i^3}{12} + \sum_{i=1}^n \frac{E_i}{E_c} \cdot b \cdot d_i \cdot a_i^2$$

Formula (4.5)

Tabular calculation:

i	$\frac{E_i}{E_c} \cdot A_i$	a_i	$I_{intrinsic}$	$\frac{E_i}{E_c} \cdot A_i \cdot a_i^2$
		$= o_i - z_s$	$= \frac{b \cdot d_i^3}{12}$	
	[cm ²]	[cm]	[cm ⁴]	[cm ⁴]
1	400,00	-4,108	533,33	6.750
2	400,00	1,892	533,33	1.432
3	135,00	6,567	20,50	5.822
Sum	1.457,85		1.027,16	14.004

$$\underline{I_{net}} = 1.027,16 + 14.004 = \underline{15.091 \text{ cm}^4}$$

Section moduli

$$W_{net,i} = \frac{I_{net}}{Z_i}$$

Top edge fibre of the X-Lam element

$$z_o = -z_s = -6,108 \text{ cm}$$

$$W_{net,o} = \frac{15.091}{-6,108} = -2.471 \text{ cm}^3$$

Bottom edge fibre of the X-Lam element

$$z_u = d_{fi} - z_s = (d - d_{ef}) - z_s = (16 - 2,65) - 6,108 = 7,242 \text{ cm}$$

$$W_{net,u} = \frac{15.091}{7,242} = 2.084 \text{ cm}^3$$

Static moment (rolling shear)

$$S_{R,net} = \sum_{i=1}^R \frac{E_i}{E_c} \cdot A_i \cdot |a_i|$$

$$S_{R,net} = A_1 \cdot |a_1|$$

$$S_{R,net} = 400 \cdot 4,108 = 1.643 \text{ cm}^3$$

Formula (4.7)

Stress curves

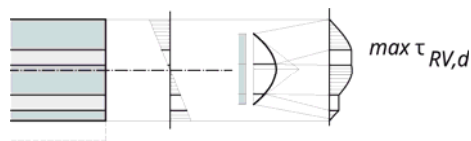

The effective moment of inertia I_{ef} is only required for verifications in the serviceability limit states and therefore is not determined for the charred cross-section.

11.1.5 X-LAM cross-section with seven layers

Given: X-LAM element X-LAM 220 L7s
 Build-up: 40l – 20w – 40l – 20w – 40l – 20w – 40l

BSP 220 L7s

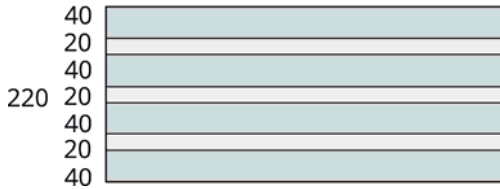

Strength class of all board layers: C24

Characteristic material values:

Modulus of elasticity $E_{0,mean} = 11.000 \text{ N/mm}^2$

Rolling shear modulus $G_{R,mean} = 50 \text{ N/mm}^2$

Reference length for calculation according to the Gamma method $\ell_{ref} = 5,5 \text{ m}$

Sought: Cross-sectional values for load-bearing capacity and serviceability.

Cross-sectional values for load-bearing capacity

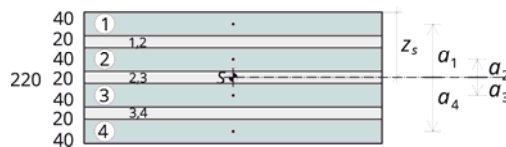

Position of the centre of gravity

$$z_s = \frac{\sum_{i=1}^n \frac{E_i}{E_c} \cdot b \cdot d_i \cdot o_i}{\sum_{i=1}^n \frac{E_i}{E_c} \cdot b \cdot d_i}$$

Tabular calculation:

<i>i</i>	<i>b</i>	$\frac{E_i}{E_c}$	<i>d_i</i>	$\frac{E_i}{E_c} \cdot A_i$	<i>o_i</i>	$\frac{E_i}{E_c} \cdot A_i \cdot o_i$
				$= b \cdot d_i$		
	[cm]	[-]	[cm]	[cm ²]	[cm]	[cm ³]
1	100	1,000	4,00	400,00	2,00	800
2	100	1,000	4,00	400,00	8,00	3.200
3	100	1,000	4,00	400,00	14,00	5.600
4	100	1,000	4,00	400,00	20,00	8.000
Sum				1.600,00		17.600

$$\underline{z_s} = \frac{17.600}{1.600} = \underline{110 \text{ mm}}$$

Symmetrical cross-section

$$z_s = \frac{h}{2}$$

$$z_s = \frac{220}{2} = \underline{110 \text{ mm}}$$

Moment of inertia (net value - rigid)

$$I_{net} = \sum_{i=1}^n \frac{E_i}{E_c} \cdot \frac{b \cdot d_i^3}{12} + \sum_{i=1}^n \frac{E_i}{E_c} \cdot b \cdot d_i \cdot a_i^2$$

Tabular calculation:

I	$\frac{E_i}{E_c} \cdot A_i$	a_i	$I_{intrinsic}$	$\frac{E_i}{E_c} \cdot A_i \cdot a_i^2$
		$= o_i - z_s$	$= \frac{b \cdot d_i^3}{12}$	
	[cm²]	[cm]	[cm⁴]	[cm⁴]
1	400,00	- 9	533,33	32.400
2	400,00	- 3	533,33	3.600
3	400,00	3	533,33	3.600
4	400,00	9	533,33	32.400
Sum	1.600,00		2.133,33	72.000

$$I_{net} = 2.133,33 + 72.000 = \underline{74.133 \text{ cm}^4}$$

Section modulus

$$W_{net} = \frac{I_{net}}{\max\{z_o; z_u\}}$$

$$z_o = z_u = z_s = 11 \text{ mm}$$

$$W_{net} = \frac{74.133}{11} = \underline{6.739 \text{ cm}^3}$$

Static moment (rolling shear)

$$S_{R,net} = \sum_{i=1}^R \frac{E_i}{E_n} \cdot A_i \cdot |a_i|$$

$$S_{R,net} = A_1 \cdot |a_1| + A_2 \cdot |a_2|$$

$$S_{R,net} = 400 \cdot 9 + 400 \cdot 3 = \underline{4.800 \text{ cm}^3}$$

Cross-sectional values for serviceability

The extended Gamma method

For cross-sections with four and more longitudinal layers, the extended Gamma method according to Schelling has to be applied. The γ values must be calculated via a linear equation system and no longer on the basis of a closed formula, as described in Annex A.1.

$$[V] \cdot \gamma = s$$

Matrix

Coefficient matrix [V]				
	1	2	3	4
1	$\left[C_{1,2} + \frac{\pi^2 EA_1}{\ell^2} \right] \cdot a_1$	$-C_{1,2} \cdot a_2$	0	0
2	$-C_{1,2} \cdot a_1$	$\left[C_{1,2} + C_{2,3} + \frac{\pi^2 EA_2}{\ell^2} \right] \cdot a_2$	$-C_{2,3} \cdot a_3$	0
3	0	$-C_{2,3} \cdot a_2$	$\left[C_{2,3} + C_{3,4} + \frac{\pi^2 EA_3}{\ell^2} \right] \cdot a_3$	$-C_{3,4} \cdot a_4$
4	0	0	$-C_{3,4} \cdot a_3$	$\left[C_{3,4} + \frac{\pi^2 EA_4}{\ell^2} \right] \cdot a_4$

Right-hand side s	
	1
1	$-C_{1,2} \cdot a_{1,2}$
2	$-C_{2,3} \cdot a_{2,3} + C_{1,2} \cdot a_{1,2}$
3	$-C_{3,4} \cdot a_{3,4} + C_{2,3} \cdot a_{2,3}$
4	$C_{3,4} \cdot a_{3,4}$

Tabular calculation:

<i>i</i>	<i>j</i>	<i>b</i>	$\frac{E_i}{E_c}$	d_{ij}	$\frac{E_i}{E_c} \cdot A_i$	a_i	$G_{j,k}$	$C_{j,k}$	$\Delta a_{j,k}$	$\frac{\pi^2 E \cdot A_i}{\ell^2}$
							$= \frac{b \cdot G_{j,k}}{d_{j,k}}$			
		[mm]	[-]	[mm]	[mm ²]	[mm]	[N/mm]	[N/mm ²]	[mm]	[N/mm ²]
1		1000	1,00	40	40.000	-90				143,56
	1,2	1000	0,00	20			50	2.500	60	
2		1000	1,00	40	40.000	-30				153,56
	2,3	1000	0,00	20			50	2.500	60	
3		1000	1,00	40	40.000	30				143,56
	3,4	1000	0,00	20			50	2.500	60	
4		1000	1,00	40	40.000	90				143,56

Matrix with numerical values:

Coefficient matrix				
[V]				
	1	2	3	4
1	-237.920	75.000	0	0
2	225.000	-154.307	75.000	0
3	0	75.000	154.307	-225.000
4	0	0	-75.000	237.920

Right-hand side	
s	
1	-150.000
2	0
3	0
4	150.000

Solution of the equation system

$$[V] \cdot y = s$$

$$y = [V]^{-1} \cdot s$$

	y
y ₁	0,9128
y ₂	0,8957
y ₃	0,8957
y ₄	0,9128

Moment of inertia

$$I_{ef} = \sum_{i=1}^n \frac{b \cdot d_i^3}{12} + \sum_{i=1}^n y_i \cdot \frac{E_i}{E_c} \cdot b \cdot d_i \cdot a_i^2$$

$$I_{ef} = 4 \cdot 533,33 + 2 \cdot (0,9128 \cdot 32.400 + 0,8957 \cdot 3.600)$$

$$I_{ef} = 2.133,33 + 65.598,48 = \underline{\underline{67.732 \text{ cm}^4}}$$

Stress curves

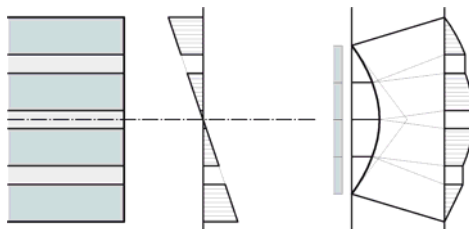

11.2 Ceilings

11.2.1 Ceiling as double-span girder

Given:

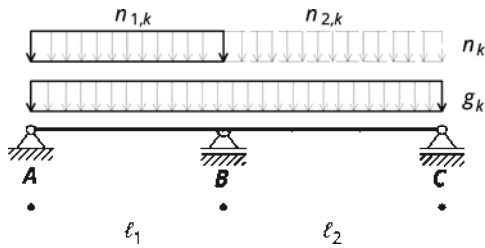

Apartment ceiling, $l_1 = 4,5 \text{ m}$; $l_2 = 5,2 \text{ m}$

Utilisation class 1

Fire resistance requirement: R60 unilateral

Impacts:

Live load: $n_k = 2,5 \text{ kN/m}^2$, Category A

Permanent superimposed loads: $g_{2,k} = 2,0 \text{ kN/m}^2$

Width of the ceiling span: $b = 7,0 \text{ m}$

Sought: Dimensioning for load-bearing capacity and serviceability

Calculation

Pre-dimensioning

$$\frac{d}{\ell} = \frac{1}{30} \div \frac{1}{20} \rightarrow d = 173 \div 260 \text{ mm with } \ell = \ell_2$$

selected cross-section: X-Lam 220 L7s2 (30l – 30l – 30w – 40l – 30w – 30l – 30l)

BSP 220 L7s2

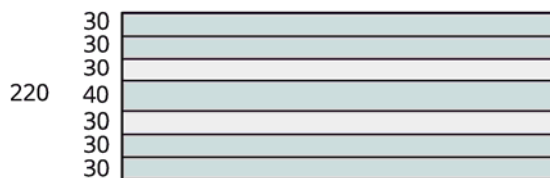

Impacts and coefficients

		$k\text{N/m}^2$	γ	KLED	k_{mod}	ψ_0	ψ_1	ψ_2
$g_{1,k}$	G	1,21	1,35	permanent	0,60	-	-	-
$g_{2,k}$		2,00						
n_k	NA	2,50	1,50	medium	0,80	0,70	0,50	0,20

Dead weight

$$g_{1,k} \approx \rho_{mean} \cdot A_{gross} = 550 \text{ kg/m}^3 \cdot 100 \text{ cm} \cdot 22 \text{ cm} \cdot 10^{-6} = 1,21 \text{ kN/m}^2$$

Sum of permanent impacts

$$g_k = g_{1,k} + g_{2,k} = 1,21 + 2,00 = 3,21 \text{ kN/m}^2$$

Cross-sectional values**Load-bearing capacity**Section modulus $W_{net} = 7.358 \text{ cm}^3$ Equivalent area for shear verification: $A_{t,R,net} = \frac{1,5 \cdot I_{0,net} \cdot b}{S_{0,R,net}} = 2.529 \text{ cm}^2$ **Serviceability**From the different span lengths result different effective moments of inertia. With length ratios of $\ell_{max} / \ell_{min} \leq 1,25$, being on the safe side, I_{ef} may be chosen for ℓ_{ref} .

$$\ell_{ref} = 0,8 \cdot 4,5 = 3,6 \text{ m} \quad I_{ef} = 62.586 \text{ cm}^4$$

By iteration from the table values:

$$\ell_{ref} = 3,0 \text{ m} \quad I_{ef} = 57.680 \text{ cm}^4$$

$$\ell_{ref} = 4,0 \text{ m} \quad I_{ef} = 65.856 \text{ cm}^4$$

$$E_{0,mean} = 11.000 \text{ N/mm}^2$$

The substitute cross-section for calculation in a framework programme results in:

$$b_{ef} / h = 71/22 \text{ cm, with } b_{ef} = \frac{I_{ef}}{I_{net}}$$

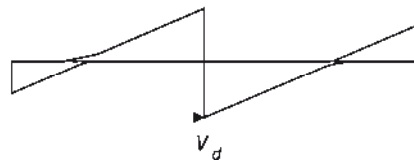
Internal forces**Moment**

Maximum moment across the central support B:

$$M_{g,k} = -9,59 \text{ kNm}$$

$$M_{n_1,k} = -2,94 \text{ kNm}$$

$$M_{n_2,k} = -4,53 \text{ kNm}$$

Decisive combination of loading conditions in the rare design situation:

$$M_d = \gamma_G \cdot M_{g,k} + \gamma_Q (M_{n_1,k} + M_{n_2,k})$$

$$M_d = 1,35 \cdot (-9,59) + 1,5 \cdot (-2,94 - 4,53)$$

$$M_d = -12,94 - 11,20 = \underline{-24,14 \text{ kNm}} \quad (k_{mod} = 0,8)$$

Lateral force

Maximum lateral force to the right of the central support B:

$$V_{g,k} = 10,19 \text{ kN}$$

$$V_{n_1,k} = 0,56 \text{ kN}$$

$$V_{n_2,k} = 7,37 \text{ kN}$$

Cross-section
table

Decisive combination of loading conditions in the rare design situation:

$$V_d = \gamma_G \cdot V_{g,k} + \gamma_Q (V_{n1,k} + V_{n2,k})$$

$$V_d = 1,35 \cdot 10,19 + 1,5 \cdot (0,56 + 7,37)$$

$$\underline{V_d} = 13,76 + 11,90 = \underline{25,66 \text{ kN}} \quad (k_{\text{mod}} = 0,8)$$

Support responses

$$B_{g,k} = 19,54 \text{ kN}$$

$$B_{n1,k} = 6,84 \text{ kN}$$

$$B_{n2,k} = 8,38 \text{ kN}$$

Decisive combination of loading conditions in the rare design situation:

$$B_d = \gamma_G \cdot B_{g,k} + \gamma_Q (B_{n1,k} + B_{n2,k})$$

$$B_d = 1,35 \cdot 19,54 + 1,5 \cdot (6,84 + 8,38)$$

$$\underline{B_d} = 26,38 + 22,83 = \underline{49,21 \text{ kN}} \quad (k_{\text{mod}} = 0,8)$$

Deflections

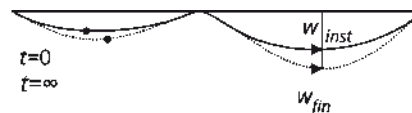
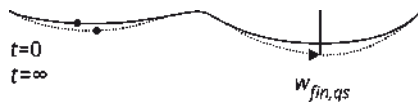

Highest deflection in span 2, at point $x = 3,5$ m from support B

$$w_{g,k} = w_{g1,k} + w_{g2,k} = 0,799 + 1,321 = 2,120 \text{ mm}$$

$$w_{n1,k} = -0,733 \text{ mm} \quad (\text{not considered, as it has a beneficial effect})$$

$$w_{n2,k} = 2,336 \text{ mm}$$

Quasi-permanent design situation

$$W_{fin,qs} = W_{inst,qs} + W_{creep}$$

$$W_{creep} = k_{def} \cdot W_{inst,qs}$$

$$W_{inst,qs} = w_{g,k} + \psi_2 \cdot w_{n2,k}$$

$$W_{inst,qs} = 2,120 + 0,30 \cdot 2,336 = 2,821 \text{ mm}$$

$$W_{creep} = 0,8 \cdot 2,821 = 2,260 \text{ mm}$$

$$\underline{W_{fin,qs}} = 2,821 + 2,260 = \underline{5,1 \text{ mm}}$$

Characteristic design situation

$$W_{fin} = W_{inst} + W_{creep}$$

$$W_{inst} = w_{g,k} + w_{n2,k}$$

$$\underline{W_{inst}} = 2,120 + 2,336 = \underline{4,5 \text{ mm}}$$

$$\underline{W_{fin}} = 4,456 + 2,260 = \underline{6,7 \text{ mm}}$$

Verification

Ultimate limit states

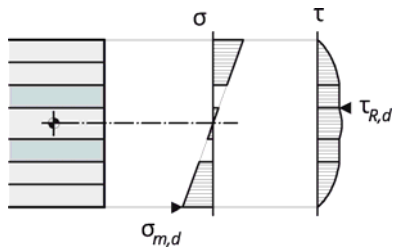

Verification of bending stresses

$$\sigma_{m,d} \leq f_{m,d}$$

$$\sigma_{m,d} = \frac{M_d}{W_{net}} = \frac{-24,14}{7.358} \cdot 1000 = -3,28 \text{ N/mm}^2$$

$$f_{m,d} = k_{mod} \frac{f_{m,k}}{\gamma_m} = 0,8 \cdot \frac{24}{1,25} = 15,36 \text{ N/mm}^2$$

$$3,28 \text{ N/mm}^2 \leq 15,36 \text{ N/mm}^2 \quad \checkmark \text{ fulfilled (22 \%)}$$

Verification of shear stresses

$$\tau_{R,d} \leq f_{VR,d}$$

$$\tau_{R,d} = \frac{V_d S_{0,net}}{I_{0,net} b} = 1,5 \cdot \frac{V_d}{A_{t,R,net}} = 1,5 \cdot \frac{25,66}{2.529} \cdot 10 = 0,15 \text{ N/mm}^2$$

$$f_{VR,d} = k_{mod} \frac{f_{VR,k}}{\gamma_m} = 0,8 \cdot \frac{1,1}{1,25} = 0,70 \text{ N/mm}^2$$

$$0,15 \text{ N/mm}^2 \leq 0,70 \text{ N/mm}^2 \quad \checkmark \text{ fulfilled (22 \%)}$$

Serviceability limit states

Deflections

Verification in the quasi-permanent design situation (appearance)

End deformation

$$w_{fin,qs} \leq \ell 250$$

$$w_{fin,qs} = 5,1 \text{ mm}$$

$$\ell 250 = \frac{5.200}{250} = 20,8 \text{ mm}$$

$$5,1 \text{ mm} \leq 20,8 \text{ mm} \quad \checkmark \text{ fulfilled (25 \%)}$$

Verification in the characteristic design situation (avoidance of damage)

Initial deformation

$$w_{inst} \leq \ell 300$$

$$w_{inst} = 4,5 \text{ mm}$$

$$\ell 300 = \frac{5.200}{300} = 17,3 \text{ mm}$$

$$4,5 \text{ mm} \leq 17,3 \text{ mm} \quad \checkmark \text{ fulfilled (26 \%)}$$

End deformation

$$w_{fin} \leq \ell 200$$

$$w_{fin} = 6,7 \text{ mm}$$

$$\ell 200 = \frac{5,200}{200} = 26,0 \text{ mm}$$

$$6,7 \text{ mm} \leq 26,0 \text{ mm} \quad \checkmark \text{ fulfilled (26 \%)}$$

The end deformation in the characteristic design situation must be applied as the maximum value of deflection to be expected for the design of possible expansion joints.

Vibrations**Stiffnesses:**

In the ceiling's direction of span:

$$(E \cdot I)_\ell = E \cdot I_{0,ef} = 11.000 \cdot 62.586 \cdot 10^{-5} = 6.884 \text{ kNm}^2 / m$$

Transverse to the ceiling's direction of span:

6 cm of cement screed, $E = 26.000 \text{ N/mm}^2$

$$(E \cdot I)_b = E \cdot I = 26.000 \cdot \frac{100 \cdot 6^3}{12} \cdot 10^{-5} = 468 \text{ kNm}^2 / m$$

Frequency criterion

Influence of transverse distribution

$$k_{transverse} = \sqrt{1 + \left[\left(\frac{\ell}{b} \right)^2 + \left(\frac{\ell}{b} \right)^4 \right] \cdot \frac{(E \cdot I)_b}{(E \cdot I)_\ell}}$$

$$k_{transverse} = \sqrt{1 + \left[\left(\frac{5,2}{7,0} \right)^2 + \left(\frac{5,2}{7,0} \right)^4 \right] \cdot \frac{468}{6.884}} = 1,029$$

Influence of the static system

From Table 6-, for $\ell_{min} / \ell_{max} = 4,5 / 5,2 = 0,865$, results $k_e = 1,113$.

$$f_1 = \frac{\pi}{2 \cdot \ell^2} \cdot \sqrt{\frac{E \cdot I_0}{m}} \cdot k_{transverse} \cdot k_e$$

$$m = g_{1,k} + g_{2,k} = \frac{3.210 \text{ N/m}}{9,81 \text{ m/s}^2} \approx 327 \text{ kg/m}^2$$

$$f_1 = \frac{\pi}{2 \cdot 5,2^2} \cdot \sqrt{\frac{11.000 \cdot 62.586}{327} \cdot 10^{-2}} \cdot 1,029 \cdot 1,113 = 9,65 \text{ Hz}$$

$$f_1 = 9,65 \text{ Hz} \geq 8 \text{ Hz} \quad \checkmark \text{ fulfilled (vibration class I)}$$

Stiffness criterion

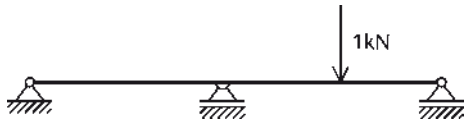

Deformation as a consequence of a unit load $F = 1\text{kN}$ at the most unfavourable point for the one-metre strip (without load distribution):

$$w_{stat} = \frac{F \cdot \ell^3}{48 \cdot (E \cdot I)_\ell \cdot b_F}$$

Load distribution in the transverse direction can be determined from:

$$b_F = \min \left\{ \frac{\ell}{1,1} \cdot 4 \sqrt{\frac{(E \cdot I)_b}{(E \cdot I)_\ell}} ; b \right\}$$

Assuming the stiffness ratios $\frac{(E \cdot I)_b}{(E \cdot I)_\ell} = \frac{468}{6.884} = \frac{1}{14,71}$ results

$$b_F = \min \left\{ \frac{\ell}{1,1} \cdot 4 \sqrt{\frac{(E \cdot I)_b}{(E \cdot I)_\ell}} ; b \right\} = \min \{ 2,41 ; 7,0 \} = 2,41 \text{ m}$$

Thus, deformation with load distribution is:

$$w_{stat} = \frac{F \cdot \ell^3}{48 \cdot (E \cdot I)_\ell \cdot b_F} = \frac{1000 \cdot 5,2^3}{48 \cdot 6.884 \cdot 2,41} = 0,18 \text{ mm}$$

The ceiling corresponds to vibration class I

$$w_{stat} = 0,18 \text{ mm} \leq 0,25 \text{ mm} \checkmark \text{ fulfilled (vibration class I)}$$

Vibration acceleration

For ceilings, a minimum frequency of $f_{1,\min} = 4,5\text{Hz}$ must be complied with in any case.

For ceilings, for which the frequency criterion cannot be fulfilled ($f_{1,\min} \leq f_1 \leq f_{gr}$), upon further compliance with the stiffness criterion, vibration verification is possible via vibration acceleration.

For completeness' sake, vibration acceleration is determined, although it is not required for the verification in the present case.

For cross-laminated timber ceilings with floating screed and heavy floor structure, from Table 6-6, the degree of damping results as follows

$$D = 0,04$$

The modal mass is

$$M = m \cdot \frac{\ell}{2 \cdot k_{\text{transverse}}} \cdot b = 327 \cdot \frac{5,2}{2 \cdot 1,029^2} \cdot 7 = 5.621 \text{ kg}$$

$$a_{\text{rms}} = \frac{0,4 \cdot \alpha \cdot F_0}{2 \cdot D \cdot M}$$

Weight force of a person walking on the ceiling considered

$$F_0 = 700 \text{ N}$$

Coefficient for consideration of the influence of the natural frequency on vibration acceleration

$$\alpha = e^{-0,47 \cdot f_1} = e^{-0,47 \cdot 9,65} = 0,011$$

$$a_{\text{rms}} = \frac{0,4 \cdot 0,011 \cdot 700}{2 \cdot 0,04 \cdot 5.621} = 0,0068 \text{ m/s}^2$$

$$a_{\text{gr}} = 0,05 \text{ m/s}^2 \checkmark \text{ fulfilled (vibration class I)}$$

Ultimate limit states in the event of fire

Residual cross-section

$$30\text{l} - 30\text{l} - 30\text{w} - 40\text{l} - 30\text{w} - 5\text{l}$$

Cross-sectional values

$$W_{\text{net},fi} = 2.291 \text{ cm}^3$$

$$A_{\tau,R,fi} = 1.020 \text{ cm}^2$$

Internal forces

Moment

Decisive combination of loading conditions in the rare design situation:

$$M_{fi,d} = M_{g,k} + \psi_1 \cdot (M_{n1,k} + M_{n2,k})$$

$$M_{fi,d} = -9,59 + 0,5 \cdot (-2,94 - 4,53)$$

$$\underline{M_{fi,d} = -9,59 - 3,73 = -13,32 \text{ kNm}}$$

Lateral force

Decisive combination of loading conditions in the rare design situation:

$$V_{fi,d} = V_{g,k} + \psi_1 \cdot (V_{n1,k} + V_{n2,k})$$

$$V_{fi,d} = 10,19 + 0,5 \cdot (0,56 + 7,37)$$

$$\underline{V_{fi,d} = 10,19 + 3,96 = 14,16 \text{ kN}}$$

Verification of bending stresses in the event of fire

$$\sigma_{m,fi,d} \leq f_{m,fi,d}$$

$$\sigma_{m,fi,d} = \frac{M_{fi,d}}{W_{\text{net},fi}} = \frac{-13,32}{2.291} \cdot 1000 = -5,81 \text{ N/mm}^2$$

Cross-section
table

$$f_{m,fi,d} = k_{fi} \cdot k_{mod,fi} \cdot \frac{f_{m,k}}{Y_{m,fi}} = 1,15 \cdot 1,0 \cdot \frac{24}{1,0} = 27,6 \text{ N/mm}^2$$

$$5,81 \text{ N/mm}^2 \leq 27,6 \text{ N/mm}^2 \quad \checkmark \text{ fulfilled (21 \%)}$$

Verification of shear stresses in the event of fire

$$\tau_{R,fi,d} \leq f_{R,fi,d}$$

$$\tau_{R,fi,d} = \frac{V_{fi,d}}{A_{\tau,R,net,fi}} = \frac{14,16}{1,020} \cdot 10 = 0,14 \text{ N/mm}^2$$

$$f_{R,fi,d} = k_{fi} \cdot k_{mod,fi} \cdot \frac{f_{VR,k}}{Y_{m,fi}} = 1,15 \cdot 1,0 \cdot \frac{1,1}{1,0} = 1,26 \text{ N/mm}^2$$

$$0,14 \text{ N/mm}^2 \leq 1,26 \text{ N/mm}^2 \quad \checkmark \text{ fulfilled (11 \%)}$$

11.2.2 Design

The formation of butt joints is discussed in 9.1., page 97.

11.2.3 Model assumptions

Load distribution

For the load propagation in walls parallel to the main direction of span (according to Figure 11-1) or in columns (according to Figure 11-2), a load propagation angle between 35° and 45° to the vertical is assumed. Since dimensioning normally takes place at one-metre strips, the impact acting on the width b_m must be referred to the one-metre strip for dimensioning.

$$q = q_W \cdot \frac{1\text{ m}}{b_m} \quad (11.1)$$

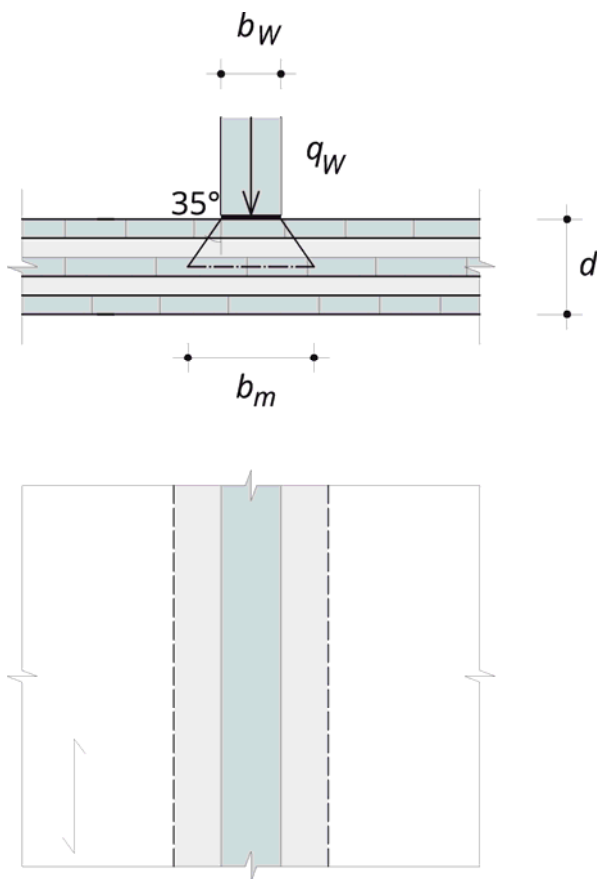

Figure 11-1: Load distribution of wall loads in direction of span

$$Q = Q_{ST} \cdot \frac{1m}{b_m} \tag{11.2}$$

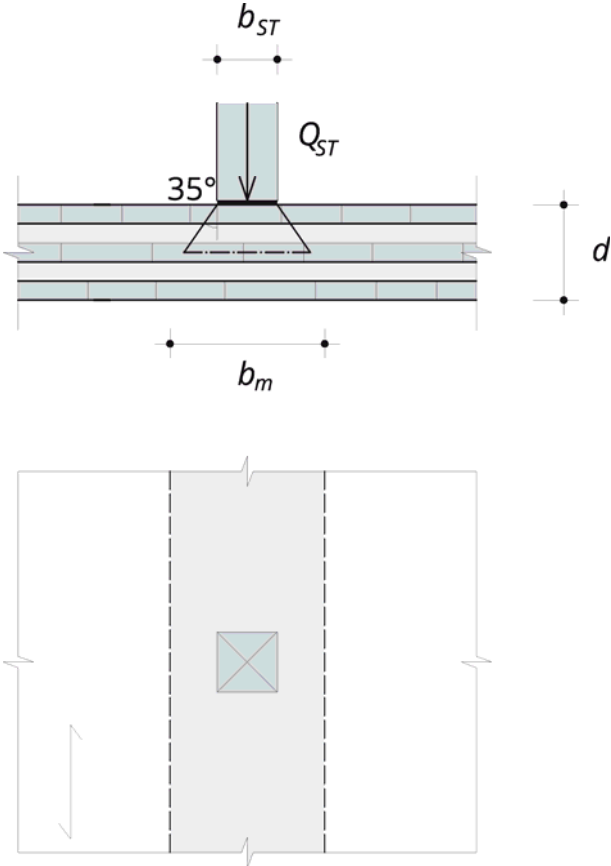
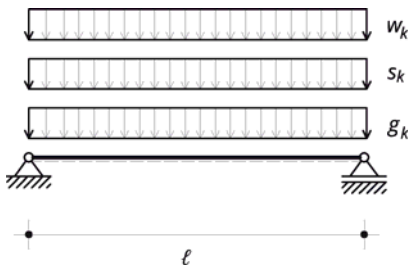

Figure 11-2: Load distribution of point loads

11.3 Roofs

11.3.1 Flat roof as a single-span girder



- Given:** Single-span girder $l = 4,5\text{ m}$
 Utilisation class 1
 Impacts:
 Permanent superimposed loads $g_{2,k} = 0,6\text{ kN/m}^2$
 Snow $s_k = 1,5\text{ kN/m}^2$
 Wind $w_k = 0,2\text{ kN/m}^2$

- Sought:** Dimensioning for load-bearing capacity and serviceability.
 Vibration class III (no requirement)

Calculation

Pre-dimensioning

$$\frac{d}{l} = \frac{1}{30} \rightarrow d = \frac{4,500}{30} = 150\text{ mm}$$

selected cross-section: X-Lam 160 L5s (40l – 20w – 40l – 20w – 40l)

BSP 160 L5s

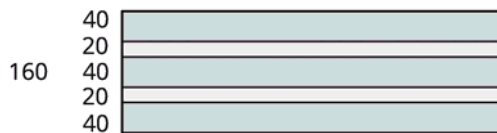

Impacts

		$k\text{N/m}^2$	γ	KLED	k_{mod}	ψ_0	ψ_1	ψ_2
$g_{1,k}$	G	0,88	1,35	permanent	0,60	-	-	-
$g_{2,k}$		0,60						
s_k	S2	1,50	1,50	brief	0,90	0,50	0,20	0,00
w_k	W	0,20	1,50	brief	0,90	0,60	0,20	0,00

Dead weight

$$g_{1,k} \approx \rho_{mean} \cdot A_{gross} = 550\text{ kg/m}^3 \cdot 100 \cdot 6 \cdot 10^{-4} = 0,88\text{ kN/m}^2$$

$$g_k = g_{1,k} + g_{2,k} = 0,88 + 0,06 = 1,48\text{ kN/m}^2$$

Cross-sectional values**Load-bearing capacity**

$$W_{0,net} = 3.800 \text{ cm}^3$$

$$S_{R,net} = 2.400 \text{ cm}^3$$

$$I_{0,net} = 30.400 \text{ cm}^4$$

Serviceability

$$\ell_{ref} = 4,5 \text{ m}$$

$$I_{0,ef} = 28.124 \text{ cm}^4$$

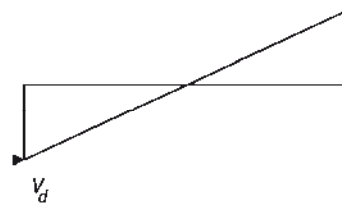
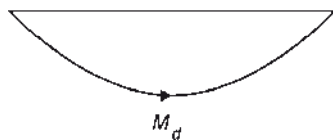
Internal forces**Moments**

$$M_{i,k} = \frac{q \cdot \ell^2}{8}$$

$$M_{g,k} = \frac{1,48 \cdot 4,5^2}{8} = 3,75 \text{ kNm}$$

$$M_{s,k} = \frac{1,5 \cdot 4,5^2}{8} = 3,80 \text{ kNm}$$

$$M_{w,k} = \frac{0,2 \cdot 4,5^2}{8} = 0,51 \text{ kNm}$$

In the decisive combination of loading conditions

$$M_d = \gamma_G \cdot M_{g,k} + \gamma_Q \cdot M_{s,k} + \gamma_Q \cdot \psi_0 \cdot M_{w,k}$$

$$M_d = 1,35 \cdot 3,75 + 1,5 \cdot 3,8 + 1,5 \cdot 0,6 \cdot 0,51$$

$$\underline{M_d} = 5,06 + 5,7 + 0,46 = \underline{11,22 \text{ kNm}} \quad (k_{mod} = 0,9)$$

Lateral force

$$V_i = \frac{q \cdot \ell}{2}$$

$$V_{g,k} = \frac{1,48 \cdot 4,5}{2} = 3,33 \text{ kN}$$

$$V_{s,k} = \frac{1,5 \cdot 4,5}{2} = 3,38 \text{ kN}$$

$$V_{w,k} = \frac{0,2 \cdot 4,5}{2} = 0,45 \text{ kN}$$

In the decisive combination of loading conditions

$$V_d = \gamma_G \cdot V_{g,k} + \gamma_Q \cdot V_{s,k} + \gamma_Q \cdot \psi_0 \cdot V_{w,k}$$

$$V_d = 1,35 \cdot 3,33 + 1,5 \cdot 3,38 + 1,5 \cdot 0,6 \cdot 0,45$$

$$\underline{V_d} = 4,50 + 5,07 + 0,41 = \underline{9,98 \text{ kNm}} \quad (k_{mod} = 0,9)$$

Deflections

$$w_{i,k} = \frac{5 \cdot q \cdot \ell^4}{384 \cdot EI_{ef}}$$

$$EI_{ef} = 1.100 \cdot 28.124 \cdot 10^{-4} = 3.094 \text{ kNm}^2$$

$$w_{g,k} = \frac{5 \cdot 1,48 \cdot 4,5^4}{384 \cdot 3.094} \cdot 1.000 = 2,554 \text{ mm}$$

$$w_{s,k} = \frac{5 \cdot 1,5 \cdot 4,5^4}{384 \cdot 3.094} \cdot 1.000 = 2,589 \text{ mm}$$

$$w_{w,k} = \frac{5 \cdot 0,2 \cdot 4,5^4}{384 \cdot 3.094} \cdot 1.000 = 0,345 \text{ mm}$$

Quasi-permanent design situation

$$w_{fin,qs} = w_{inst,qs} + w_{creep}$$

$$w_{creep} = k_{def} \cdot w_{inst,qs}$$

$$w_{inst,qs} = w_{g,k} + \psi_2 \cdot w_{s,k} + \psi_2 \cdot w_{w,k}$$

$$w_{inst,qs} = 2,554 + 0,00 \cdot 2,589 + 0,00 \cdot 0,345 = 2,554 \text{ mm}$$

$$w_{creep} = 0,8 \cdot 2,554 = 2,043 \text{ mm}$$

$$w_{fin,qs} = 2,554 + 2,043 = \underline{4,597 \text{ mm}}$$

Characteristic design situation

$$w_{fin} = w_{inst} + w_{creep}$$

$$w_{inst} = w_{g,k} + w_{s,k} + \psi_0 \cdot w_{w,k}$$

$$w_{inst} = 2,554 + 2,589 + 0,6 \cdot 0,345 = \underline{5,350 \text{ mm}}$$

$$w_{fin} = 5,350 + 2,043 = \underline{7,393 \text{ mm}}$$

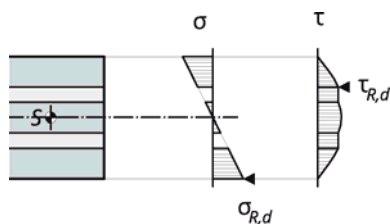
Verification**Ultimate limit states****Verification of bending stresses**

$$\sigma_{m,d} \leq f_{m,d}$$

$$\sigma_{m,d} = \frac{M_d}{W_{net}} = \frac{11,20 \cdot 100}{3.800} \cdot 10 = 2,95 \text{ N/mm}^2$$

$$f_{m,d} = k_{mod} \frac{f_{m,k}}{\gamma_m} = 0,9 \cdot \frac{24}{1,25} = 17,28 \text{ N/mm}^2$$

$$2,95 \text{ N/mm}^2 \leq 17,28 \text{ N/mm}^2 \quad \checkmark \text{ fulfilled (17 \%)}$$

Verification of shear stresses

$$\tau_{R,d} \leq f_{VR,d}$$

$$\tau_{R,d} = \frac{V_d S_{net}}{I_{net} b} = \frac{9,98 \cdot 2.400 \cdot 10}{30.400 \cdot 100} = 0,079 \text{ N/mm}^2$$

$$f_{VR,d} = k_{mod} \frac{f_{VR,k}}{\gamma_m} = 0,9 \cdot \frac{1,1}{1,25} = 0,792 \text{ N/mm}^2$$

0,079 N/mm² ≤ 0,792 N/mm² ✓ **fulfilled (10 %)**

Serviceability limit states

Deflections

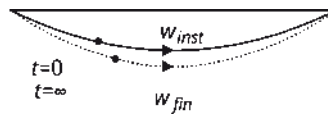

Verification in the quasi-permanent design situation (appearance)

End deformation

$$w_{fin,qs} \leq \ell 250$$

$$w_{fin,qs} = 4,60 \text{ mm}$$

$$\ell 250 = \frac{4.500}{250} = 18 \text{ mm}$$

4,60 mm ≤ 18 mm ✓ **fulfilled (26 %)**

Verification in the characteristic design situation (avoidance of damage)

Initial deformation

$$w_{inst} \leq \ell 300$$

$$w_{inst} = 5,35 \text{ mm}$$

$$\ell 300 = \frac{4.500}{300} = 15 \text{ mm}$$

5,35 mm ≤ 15 mm ✓ **fulfilled (36 %)**

End deformation

$$w_{fin} \leq \ell 200$$

$$w_{fin} = 7,39 \text{ mm}$$

$$\ell 200 = \frac{4.500}{200} = 22,5 \text{ mm}$$

7,39 mm ≤ 22,5 mm ✓ **fulfilled (33 %)**

The end deformation in the characteristic design situation must be applied as the maximum value of deflection to be expected for the design of possible expansion joints.

11.4 Barrel-shaped roof

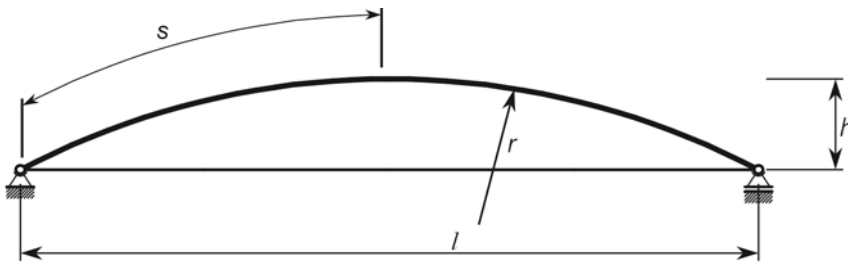

Given: Barrel-shaped roof: $l = 7,0 \text{ m}$, $h = 0,85 \text{ m}$, arc of circle with tie bar
Utilisation class 1

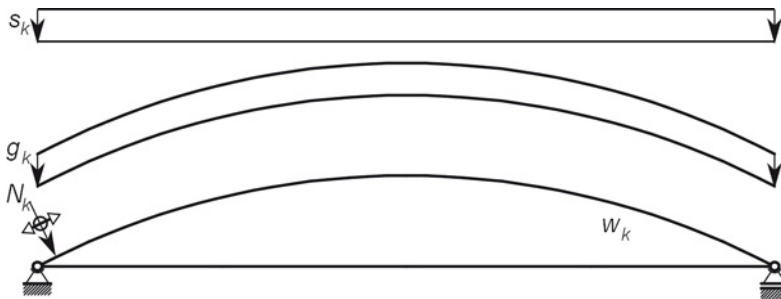

Impacts:

Permanent superimposed loads $g_{2,k} = 0,5 \text{ kN/m}^2$

Snow $s_k = 1,5 \text{ kN/m}^2$

Wind $w_A = 0,1 \text{ kN/m}^2$, $w_B = -0,4 \text{ kN/m}^2$, $w_C = -0,08 \text{ kN/m}^2$

(List according to EN 1991-1-4)

Roof elements X-Lam 130 C5s (30l - 20w - 30l - 20w - 30l) arched

Tie bars: $\varnothing 20 \text{ mm}$ per metre, S235

Sought: Dimensioning for load-bearing capacity and serviceability

Calculation

Arched elements

From the circular arched geometry results a radius of curvature associated with the details of:

$$r = \frac{\left(\frac{l}{2}\right)^2 + h^2}{2 \cdot h} = 7,631 \text{ m}$$

The maximum board thickness respectively results as follows:

$$d_{\text{max,vorh.}} \leq d_{\text{grenz}}$$

$$d_{\text{grenz}} = \frac{r}{250} = \frac{7,631}{250} = 30,5 \text{ mm}$$

$$d_{\text{max,vorh.}} = 30 \text{ mm}$$

$$30 \text{ mm} \leq 30,5 \text{ mm} \checkmark \text{ fulfilled}$$

Static calculation of the internal forces by means of EDP

Stiffness: Arch: $I_{net} = 15.675 \text{ cm}^4$; $A_{net} = 900 \text{ cm}^2$; $E = 11.000 \text{ N/mm}^2$

Tie bar: $A_{net} = 3,145 \text{ cm}^2$; $E = 210.000 \text{ N/mm}^2$

[N]

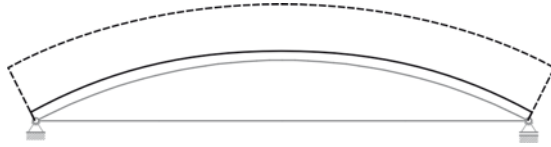

$$\min N_d = -28,71 \text{ kN} \quad \max N_d = -4,10 \text{ kN}$$

[M]

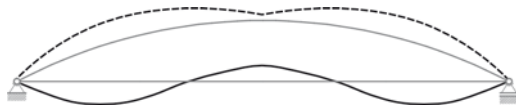

$$\min M_d = -1,96 \text{ kNm} \quad \max M_d = 5,45 \text{ kNm}$$

Verification

Arch - Ultimate limit states

Buckling: Pressure and bending conservatively with the largest internal forces $\min N_d$ and $\max M_d$. For exact calculation, the respectively associated internal forces are used.

The buckling length of two-hinged arches can be estimated with $\ell_k = 1,25 \cdot s$.

$$\text{Opening angle of the arch: } \alpha = 2 \cdot \arctan \left(\frac{b}{\left(\frac{\ell}{2} \right)^2 + h^2 - h} \right) = 54,60^\circ$$

$$\text{Arch length of half of the arch: } s = \frac{r \cdot \alpha}{2} = 3,63 \text{ m}$$

$$\text{Buckling length: } \underline{\ell_k} = 1,25 \cdot s = \underline{4,64 \text{ m}}$$

Tie bar - Load-bearing capacity

With the net cross-section, the ultimate limit state must be calculated with $\max N_d = 26,20 \text{ kN}$.

Serviceability

Analysis of the vertical crown deflection and horizontal displacement of the sliding bearing

11.5 Walls

Upright cross-laminated timber elements linearly supported at their bottom side are called walls.

11.5.1 Vertically loaded wall

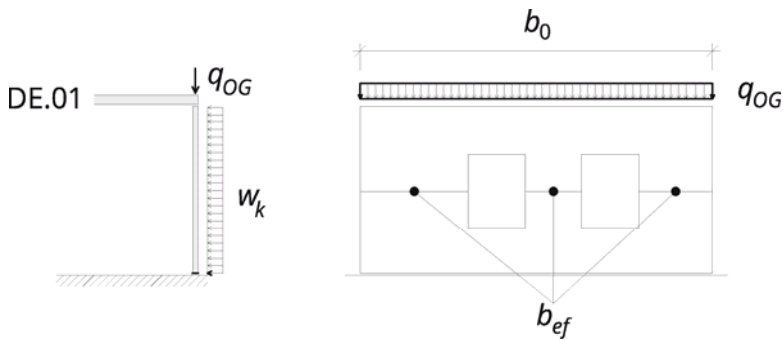

Given: Exterior wall $\ell_k = 2,95 \text{ m}$; $b_0 = 4,54 \text{ m}$; $b_{ef} = 2,40 \text{ m}$
 Utilisation class 1
 Impacts:
 Loads from rising storeys:

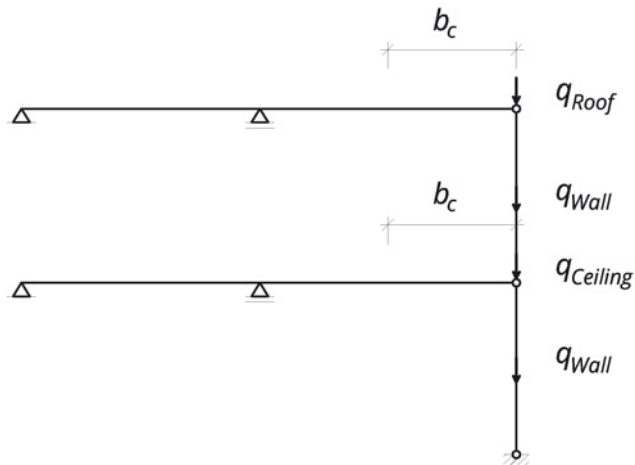

Total superimposed load for the wall: $q_d = 30 \text{ kN/m}$ (design value)

Wind pressure transverse to the wall plane $w_k = 0,8 \text{ kN/m}^2$

Element: X-Lam 90 C3s (30l – 30w – 30l)

Sought: Dimensioning for load-bearing capacity

Calculation



Cross-sectional values for the one-metre strip

$$i_{ef} = 2,97 \text{ cm} , \lambda = 99$$

$$A_{net} = 600 \text{ cm}^2 , W_{net} = 1.300 \text{ cm}^3$$

In the event of fire (R30 unilateral):

$$i_{ef,fi} = 1,63 \text{ cm} , \lambda = 181$$

$$A_{net,fi} = 335 \text{ cm}^2 , W_{net,fi} = 209 \text{ cm}^3$$

Position of the centre of gravity: $z_{fi} = 19,89 \text{ mm}$

Eccentricity due to charring: $e_{fi} = z_{kalt} - z_{fi} = 45,00 - 19,89 \text{ mm} = 25,1 \text{ mm}$

Consideration of wall openings

In case of vertical load distribution, wall openings result in larger forces in the reduced wall cross-section. In general, approximately uniformly distributed forces can be assumed.

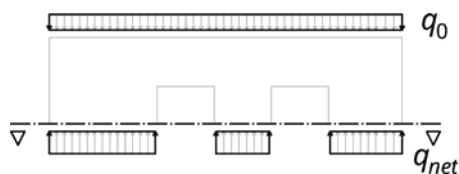

Relating to the one-metre strip, this results in

$$f_b = \frac{b_0}{b_{eff}} = \frac{4,54}{2,40} = 1,89$$

$$N_d = f_b \cdot q_d = 1,89 \cdot 30 = 57 \text{ kN}$$

$$M_d = \frac{\gamma_Q \cdot w_d \cdot \ell^2}{8} = \frac{1,5 \cdot 0,8 \cdot 2,95^2}{8} = 1,31 \text{ kNm}$$

Verification

Ultimate limit states

Buckling analysis

$$\frac{\sigma_{c,0,d}}{k_{c,y} \cdot f_{c,0,d}} + \frac{\sigma_{m,d}}{f_{m,d}} \leq 1$$

Buckling coefficient for slenderness $\lambda = 99$

$$k_{c,y} = 0,403$$

$$f_{c,0,d} = 13,4 \text{ N/mm}^2, f_{m,d} = 15,3 \text{ N/mm}^2$$

$$\frac{N_d}{A_{net}} + \frac{M_d}{W_{net}} \leq 1$$

$$\frac{57 \cdot 10}{0,403 \cdot 13,4} + \frac{1,31 \cdot 100 \cdot 10}{1,300 \cdot 15,3} \leq 1$$

$$\frac{0,95}{5,40} + \frac{1,008}{15,3} \leq 1$$

$$0,176 + 0,066 \leq 1$$

$$0,242 \leq 1 \checkmark \text{ fulfilled (24 \%)}$$

Shear stresses

Due to small lateral forces, verification of the shear stresses is omitted at this point.

Ultimate limit states in the event of fire

According to EN 1995-1-2, internal design forces in the event of fire can be determined in a simplified manner from the internal design forces of cold dimensioning:

$$N_{fi,d} \approx \eta_{fi} \cdot N_d = 0,6 \cdot 57 = 34,2 \text{ kN}$$

The design moment results from the eccentricity in the event of fire as follows:

$$M_{fi,d} = N_{fi,d} \cdot e_{fi} = 34,2 \cdot \frac{25,11}{1.000} = 0,86 \text{ kNm}$$

Buckling analysis

$$\frac{N_{fi,d}}{k_{c,y} \cdot f_{c,0,fi,d}} + \frac{M_{fi,d}}{f_{m,fi,d}} \leq 1$$

Buckling coefficient for slenderness $\lambda = 181$

(recommended limit slenderness in the event of fire $\lambda_{fi,grenz} = 200$ complied with)

$$k_{c,y} = 0,127$$

Table 5-2

Table 3-3

Table 5-2

$$f_{c,0,d} = 24,1 \text{ N/mm}^2, f_{m,d} = 27,6 \text{ N/mm}^2$$

Table 7-1

$$\frac{34,2}{335} + \frac{0,86 \cdot 100}{209} \leq 1$$

$$0,127 \cdot 24,1 + \frac{0,86 \cdot 100}{27,6} \leq 1$$

$$\frac{34,2 \cdot 10}{335} + \frac{0,86 \cdot 100 \cdot 10}{209} \leq 1$$

$$0,127 \cdot 24,1 + \frac{0,86 \cdot 100}{27,6} \leq 1$$

$$\frac{1,021}{3,06} + \frac{4,12}{27,6} \leq 1$$

$$0,334 + 0,149 \leq 1$$

$$0,484 \leq 1 \checkmark \text{ fulfilled (48 \%)}$$

Shear stresses

Due to small lateral forces, verification of the shear stresses is omitted at this point.

11.5.2 Design

11.5.3 Model assumptions – Lintels

Execution variants

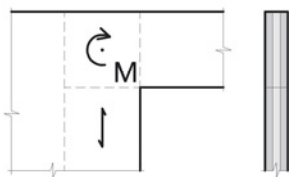
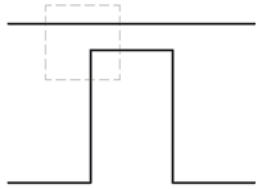

a) Lintel cut from CLT

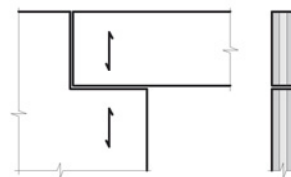

b) Lintel of CLT inserted with vertical top layer

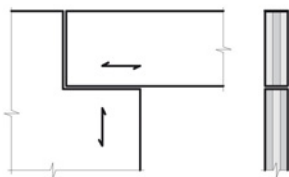

c) Lintel of CLT inserted with horizontal top layer

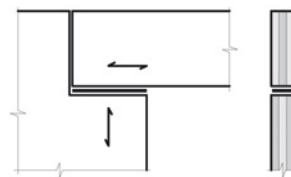

d) ... with inserted steel sheet (support pressure)

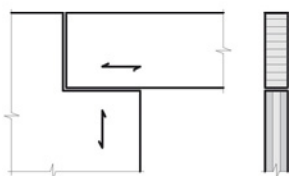

e) Lintel of CLT inserted

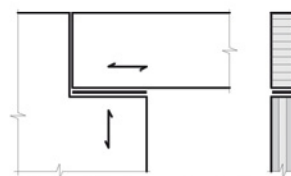

f) ... with inserted steel sheet (support pressure)

Figure 11-3: Execution variants for lintels in X-Lam walls

Figure 11-3 shows execution variants for lintels in cross-laminated timber walls. In most cases, the restraint of cut-out lintels according to Figure a) is about 60 to 70 % of the full restraint and can be obtained from the consideration of a frame – with vertical wall strips for the struts and the lintel as a waler. The further variants are single-span systems with upright girders of cross-laminated timber or glued-laminated timber. In Figure c), the reaction force is transferred from the lintel into the wall via pressing transverse to the fibre. Inserting a steel plate according to Figure d), this can be avoided, and the force is transferred via end pressing. For lintel girders of glued-laminated timber or solid wood according to Figure e), by inserting a steel plate according to Figure f), the pressing area of the upright layers of the wall can be increased to the entire girder width.

11.6 Shear walls

Wall-type girders are used as load-bearing parapet girders, attic girders, roof trusses or storey-height walls. They can be used to transfer suspended ceiling loads or the loads of projecting parts of buildings.

With girders of cross-laminated timber, compared to glued-laminated timber, a higher shear capacity can be achieved due to the interlocked layers. The cross-section usable for bending results from the sum of horizontal layers, i.e. running in the direction of load-bearing capacity.

For wall-type girders from a span-to-height ratio of about $h:\ell \geq 1:4$ on, the non-linear stress curve must be considered. The stress distribution for wall-type girders is shown as an example in Figure 11-4. While the stress curve of the beam is linear, it is highly curved for the wall-type girder. With a decreasing ℓ/h ratio, the tension zone becomes lower and the pressure zone higher. The stress at the bending tension edge of the wall-type girder does not decrease with the moment curve, but maintains its size in the span over longer distances.

Edge stresses determined according to the plate theory depend on the load application at the top and at the bottom and the ℓ/h ratio of the girder. In the very most cases they remain below the three-fold value of stress distribution of a beam assumed as linear. With a ratio of $h:\ell = 1:2$, they are about the 1,5-fold. The diagram of shear stresses likewise shows another curve, with a lower maximum compared to the beam. The maximum shear stress at $h:\ell = 1:2$ remains below the 1,5-fold of the shear stress according to the beam theory.

With continuous systems, the influence of shear deformations has an effect on internal forces. The moments at support become lower, the moments of span higher. It is recommended to determine the moments and the longitudinal bending stresses resulting therefrom as well as the deformations at a single-span girder across the longest span. Reaction forces and lateral forces can be determined considering the continuous beam effect.

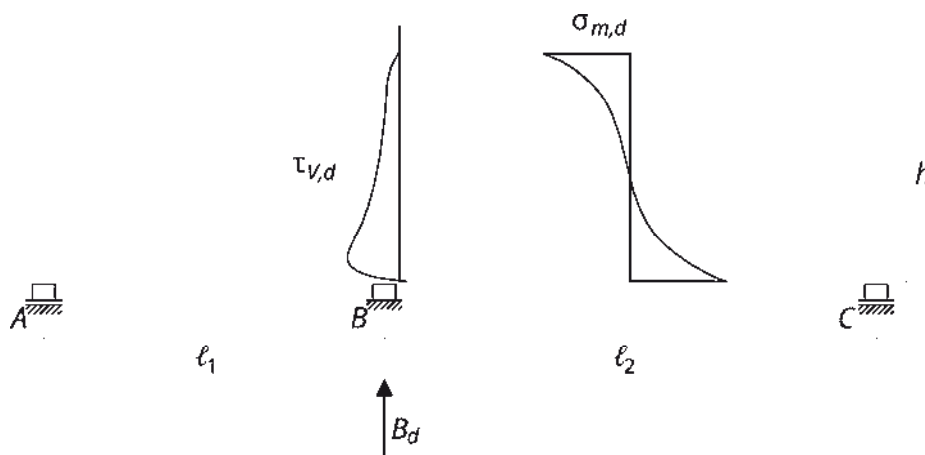
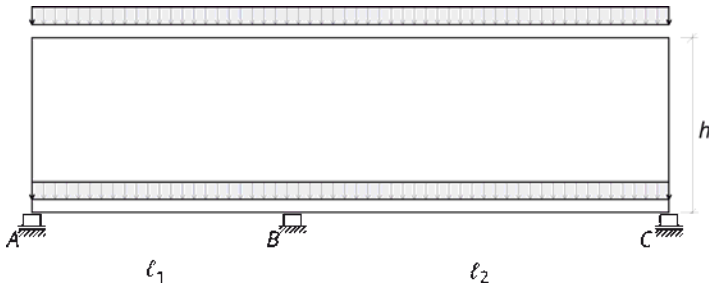

Figure 11-4: Stress distribution for wall-type girders

11.6.1 Shear walls



Given: Double-span girder $l_1 = 4,5 \text{ m}$, $l_2 = 4,5 \text{ m}$

Utilisation class 1

Impacts:

Permanent superimposed loads: top: $g_k = 4 \text{ kN/m}$, bottom: $g_k = 7,72 \text{ kN/m}$

Live loads: bottom: $n_k = 6 \text{ kN/m}$ (span-wise unfavourable) (live load category A)

Snow: top: $s_k = 3,5 \text{ kN/m}^2$ (below 1.000 m above sea level – S2)

Wind: top: $w_k = 0,5 \text{ kN/m}^2$

Cross-section: X-Lam 130 C5s (30l – 20w – 30l – 20w – 30l)

Sought: Dimensioning for load-bearing capacity and serviceability

Calculation

Impacts

		kN/m^2	$Y_G \cdot Y_Q$	KLED	k_{mod}	ψ_0	ψ_1	ψ_2
g_k	G	11,72	1,35	permanent	0,60	-	-	-
$n_{1,k}$ and $n_{2,k}$	NA	6,00	1,50	medium	0,80	0,70	0,50	0,30
s_k	S2	3,50	1,50	brief	0,90	0,50	0,20	0,00
w_k	W	0,50	1,50	brief	0,90	0,60	0,20	0,00

Design value of the impact in the decisive load combination

$$q_d = Y_G \cdot g_k + Y_Q \cdot n_k = 1,35 \cdot 11,72 + 1,50 \cdot 6,00 = 24,9 \text{ kN/m} \quad (k_{mod} = 0,8)$$

Support

$$B_d \approx 1,25 \cdot q_d \cdot \frac{l_1 + l_2}{2} = 1,25 \cdot 24,9 \cdot \frac{4,5 + 6,5}{2} = 171,2 \text{ kN} \quad (k_{mod} = 0,8)$$

Internal forces

Moment

Determined for a single-span girder with the length of $l_2 = 6,5 \text{ m}$

$$M_d = \frac{q_d \cdot l_2^2}{8} = \frac{24,9 \cdot 6,5^2}{8} = 131,5 \text{ kNm}$$

$$\sigma_d = \frac{M_d}{W_{z,90,net}} = \frac{131,5 \cdot 100 \cdot 10}{60.000} = 2,19 \text{ N/mm}^2$$

Lateral force

$$V_d = 0,625 \cdot q_d \cdot \ell_2 = 0,625 \cdot 24,9 \cdot 6,5 = 101,2 \text{ kN}$$

$$\tau_{V,S,d} = 1,5 \cdot \frac{V_d}{A_{z,90,net}} = 1,5 \cdot \frac{101,2}{1.200} \cdot 10 = 1,27 \text{ N/mm}^2$$

Deformation

Characteristic value of impact

$$q_k = g_k + n_k + \psi_0 \cdot s_k + \psi_0 \cdot w_k = 11,72 + 6,0 + 0,50 \cdot 3,5 + 0,6 \cdot 0,5 = 19,8 \text{ kN/m}$$

$$w_{inst} = \frac{5 \cdot q_k \cdot \ell_2^4}{384 \cdot E \cdot I} + \frac{q_k \cdot \ell_2^2}{8 \cdot G \cdot A_s}$$

$$I_{z,90,net} = \frac{b_{z,90,net} \cdot h^3}{12} = \frac{4 \cdot 300^3}{12} = 9.000.000 \text{ cm}^4$$

$$E = 1.100 \text{ kN/cm}^2$$

$$E \cdot I = 1.100 \cdot 9.000.000 \cdot 10^{-4} = 990.000 \text{ kNm}^2$$

$$A_s = b_{gross} \cdot h = 13 \cdot 300 = 3.900 \text{ cm}^2$$

$$G = 0,75 \cdot G = 0,75 \cdot 69 = 51,75 \text{ kN/cm}^2$$

$$G A_s = 51,75 \cdot 3.900 = 201.825 \text{ kN}$$

$$w_{inst} = \left(\frac{5 \cdot 19,8 \cdot 6,5^4}{384 \cdot 990.000} + \frac{19,8 \cdot 6,5^2}{8 \cdot 201.825} \right) \cdot 10^3 = 0,465 + 0,518 = \underline{1 \text{ mm}}$$

Support pressure

$$\sigma_{c,0,d} = \frac{B_d}{A_{c,net}} = \frac{171,2}{20 \cdot 9} \cdot 10 = 9,51 \text{ N/mm}^2$$

Wall pillar at risk of buckling above the support

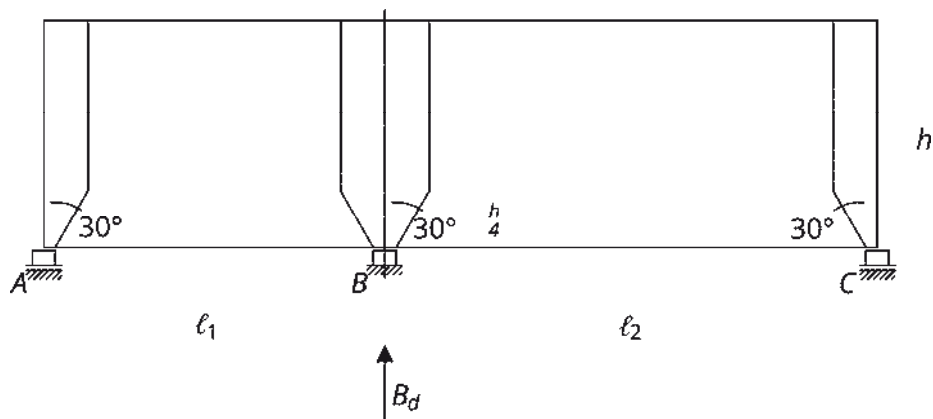

Load propagation into the wall pillar with 30°

$$b_{st} = 2 \cdot \frac{h}{4} \cdot \tan(30^\circ) = 2 \cdot \frac{300}{4} \cdot 0,577 = 86 \text{ cm}$$

$$n_d = \frac{B_d}{b_{st}} = \frac{171,2}{0,86} = 199 \text{ kN/m}$$

Related to a one-metre strip

$$n_{1,d} = n_d \cdot \frac{1}{b_{st}} = 199 \cdot \frac{1}{0,86} = 232 \text{ kN/m}$$

Buckling

$$\ell_k = h = 3,0 \text{ m}$$

$$i_{ef} = 3,91 \text{ cm}$$

$$\lambda = \frac{\ell_k}{i_{ef}} = \frac{300}{3,91} = 77$$

$$k_{c,y} = 0,622$$

$$\sigma_{c,0,d} \leq k_{c,y} \cdot f_{c,0,d}$$

$$\sigma_{c,0,d} = \frac{N_d}{A_{0,net}} = \frac{232}{900} = 2,58 \text{ N/mm}^2$$

$$A_{0,net} = 9 \cdot 100 = 900 \text{ cm}^2$$

$$f_{c,0,d} = k_{mod} \cdot \frac{f_{c,0,k}}{\gamma_M} = 0,8 \cdot \frac{21}{1,25} = 13,44 \text{ N/mm}^2$$

$$2,58 \text{ N/mm}^2 \leq 0,622 \cdot 13,44$$

$$2,58 \text{ N/mm}^2 \leq 8,36 \text{ N/mm}^2 \checkmark \text{ fulfilled (31 \%)}$$

Table 5-2

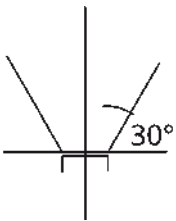

Figure 11-5: Load propagation from the support axis

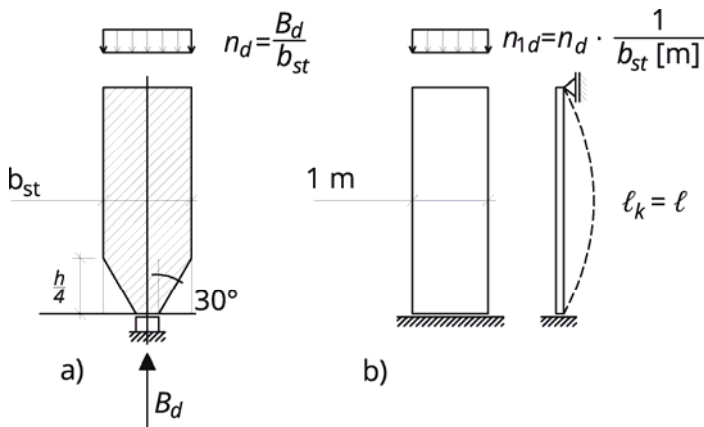

Figure 11-6: Wall pillar with conversion of the load to one column with a width of 1 m

Annex Calculation method

A.1 The extended Gamma method

The Gamma method stated in the standards is restricted to two and three longitudinal layers, i.e. three- and five-layer cross-laminated timber cross-sections. For seven and more longitudinal layers, the method must be extended. The Gamma values may then be determined via a linear equation system.

A.1.1 Prerequisites and assumptions

The flexibly connected partial cross-sections (thickness of longitudinal layers and E moduli) may each have different cross-sections and stiffnesses, but are constant along the entire girder length. The stiffness of the flexible couplings (i.e. the transverse layers with their respective thicknesses and rolling shear moduli) likewise remains constant, which can be assumed with continuous gluing of the transverse layers.

With sufficient accuracy, the longitudinal stiffnesses of the transverse layers are equated to zero in a simplified manner.

The Gamma method is based on the approach of a sinusoidally distributed load and a respective deformation shape and on the assumption that all parts of the cross-section remain planar in the sections considered.

From the equilibrium analysis at the cross-section, with application of the curvature-moment-relation and consideration of the joint displacements, a coupled differential equation system can be set up, using which the expansions and curvatures of the individual partial cross-sections can be determined. Applying the mentioned sinusoidal distribution, this differential equation system is simplified into a linear equation system, which can be resolved by the Gamma values for the individual longitudinal layers.

A.1.2 Determination of the overall centre of gravity

$$z_s = \frac{\sum_{i=1}^n \frac{E_i}{E_c} \cdot b \cdot d_i \cdot o_i}{\sum_{i=1}^n \frac{E_i}{E_c} \cdot b \cdot d_i}$$

o_i Distance of the individual centres of gravity of each longitudinal layer from the upper edge

z_s Distance of the overall centre of gravity from the upper edge

$a_i = o_i - z_s$ Distance of the individual centre of gravity of the longitudinal layer i from the overall centre of gravity

A.1.3 Setting up the equation system

For more than three longitudinal layers, the stiffness of the cross-section is no longer determined by the flexibility to the respectively adjacent longitudinal layer alone. The flexible coupling to the longitudinal layers positioned further away must be considered, as described in A.1.1.

The equation system is as follows:

$$[V] \cdot \gamma = s \quad (1)$$

$$\begin{bmatrix} v_{1,1} & v_{1,2} & 0 & 0 & 0 \\ v_{2,1} & v_{2,2} & v_{2,3} & 0 & 0 \\ 0 & v_{3,2} & v_{3,3} & v_{3,4} & 0 \\ 0 & 0 & \dots & \dots & \dots \\ 0 & 0 & 0 & v_{m,m-1} & v_{m,m} \end{bmatrix} \cdot \begin{bmatrix} \gamma_1 \\ \gamma_2 \\ \gamma_3 \\ \vdots \\ \gamma_m \end{bmatrix} = \begin{bmatrix} s_1 \\ s_2 \\ s_3 \\ \vdots \\ s_m \end{bmatrix}$$

(2)

Left-hand side

$$C_{j,k} = \frac{b \cdot G_{R,jk}}{d_{j,k}} \quad (3)$$

$$D_i = \frac{\pi^2 \cdot E_i \cdot b \cdot d_i}{\vartheta_{ref}^2} \quad (4)$$

$$v_{i,i-1} = -C_{i-1,i} \cdot a_{i-1} \quad (5)$$

$$v_{i,i} = (C_{i-1,i} + C_{i,i+1} + D_i) \cdot a_i \quad (6)$$

$$v_{i,i+1} = -C_{i,i+1} \cdot a_{i+1} \quad (7)$$

Right-hand side

$$s_i = -C_{i,i+1} \cdot (a_{i+1} - a_i) + C_{i-1,i} \cdot (a_i - a_{i-1}) \quad (8)$$

The equation system for four longitudinal layers is as follows:

$$\begin{bmatrix} v_{1,1} & v_{1,2} & 0 & 0 \\ v_{2,1} & v_{2,2} & v_{2,3} & 0 \\ 0 & v_{3,2} & v_{3,3} & v_{3,4} \\ 0 & 0 & v_{4,3} & v_{4,4} \end{bmatrix} \cdot \begin{bmatrix} \gamma_1 \\ \gamma_2 \\ \gamma_3 \\ \gamma_4 \end{bmatrix} = \begin{bmatrix} s_1 \\ s_2 \\ s_3 \\ s_4 \end{bmatrix}$$

Following insertion, it looks as follows:

$$\begin{bmatrix} (C_{1,2} + D_1) \cdot a_1 & -C_{1,2} \cdot a_2 & 0 & 0 \\ -C_{1,2} \cdot a_1 & (C_{1,2} + C_{2,3} + D_2) \cdot a_2 & -C_{2,3} \cdot a_3 & 0 \\ 0 & -C_{2,3} \cdot a_2 & (C_{2,3} + C_{3,4} + D_3) \cdot a_3 & -C_{3,4} \cdot a_4 \\ 0 & 0 & -C_{3,4} \cdot a_3 & (C_{3,4} + D_4) \cdot a_4 \end{bmatrix} \cdot \begin{bmatrix} \gamma_1 \\ \gamma_2 \\ \gamma_3 \\ \gamma_4 \end{bmatrix} = \begin{bmatrix} -C_{1,2} \cdot (a_2 - a_1) \\ -C_{2,3} \cdot (a_3 - a_2) + C_{1,2} \cdot (a_2 - a_1) \\ -C_{3,4} \cdot (a_4 - a_3) + C_{2,3} \cdot (a_3 - a_2) \\ C_{3,4} \cdot (a_4 - a_3) \end{bmatrix} \quad (9)$$

A.1.4 Solution

$$\gamma = [V]^{-1} \cdot s \quad (10)$$

The solution of the linear equation system are the Gamma values for the individual longitudinal layers.

A.1.5 Moment of inertia

The moment of inertia can be determined as with the simple Gamma method:

$$I_{ef} = \sum_{i=1}^3 \frac{E_i}{E_c} \cdot \frac{b \cdot d_i^3}{12} + \sum_{i=1}^3 \gamma_i \cdot \frac{E_i}{E_c} \cdot b \cdot d_i \cdot d_i^2 \quad (11)$$

A.1.6 Stress verifications

In the present guideline, the stress verifications are undertaken assuming rigidly connected parts of the cross-section. This corresponds to most approvals and some parts of the technical literature, and is explained in Chapter 4.

A.2 The multilayer, shear-flexibly connected beam

Timoshenko beam according to Bogensperger, Moosbrugger¹ and Altenbach et al. (1996)

A.2.1 Designation of layers and distances

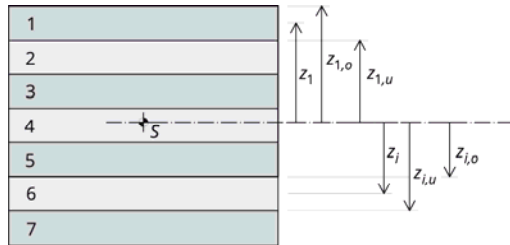

Figure 11-7: Designations for individual layers at the example of a seven-layer cross-laminated timber element

A.2.2 Overall cross-section

Position of the centre of gravity following rigid connection

n Number of layers

$\bar{z}_i = \sum_{k=1}^{i-1} d_k + \frac{d_i}{2}$ Position of the individual centres of gravity of each longitudinal layer (as measured from the upper edge)

$\bar{z}_s = \frac{\sum_{i=1}^n E_i \cdot A_i \cdot \bar{z}_i}{\sum_{i=1}^n E_i \cdot A_i}$ Overall centre of gravity (as measured from the cross-section's upper edge)

$z_i = \bar{z}_i - \bar{z}_s$ Distance of the individual centres of gravity from the centre of gravity

$z_{i,o} = z_i - \frac{d_i}{2}$ Distance of the top individual edge fibre from the centre of gravity

$z_{i,u} = z_i + \frac{d_i}{2}$ Distance of the bottom individual edge fibre from the centre of gravity

m Index of the layer containing the centre of gravity

A.2.3 Moment of inertia

$$I_{net} = \sum_{i=1}^n \frac{E_i}{E_c} \cdot \frac{b \cdot d^3}{12} + \sum_{i=1}^n \frac{E_i}{E_c} \cdot b \cdot d_i \cdot z_i^2$$

¹ Schickhofer et al. (2010)

A.2.4 Shear area

$$G \cdot A_s = \frac{\sum G \cdot A}{K_z} = \kappa \cdot \sum G \cdot A$$

Shear correction factor (transverse shear factor)

Modified for consideration of the different moduli of elasticity E and shear moduli G.

In the literature, shear correction is considered on the one hand

- via the shear correction coefficient κ_z (kappa with index z) $\kappa_z \geq 1,2$

and on the other hand

- via the shear correction factor κ (kappa without index), $\kappa = \frac{1}{K_z}$ with $\kappa \leq 0,83$.

Shear correction coefficient:

$$K_z = \frac{\sum G \cdot A}{(E \cdot I_{y,net})^2} \cdot \int_h \frac{[E(z) \cdot S(z)]^2}{G(z) \cdot b} dz \quad (12)$$

$$K_z = \frac{\sum G \cdot A}{(E \cdot I_{y,net})^2} \cdot \int_h \frac{[E(z) \cdot \int A \cdot z dz]^2}{G(z) \cdot b} dz \quad (13)$$

Shear correction factor:

$$\kappa = \frac{1}{K_z} \quad (14)$$

for rectangles: $\kappa = \frac{5}{6} = 0,83$

Standard values for cross-laminated timber made of standard laminates with different thicknesses (20, 30, 40 mm):

Type 3s: $0,15 \leq \kappa \leq 0,18$

Type 5s: $0,18 \leq \kappa \leq 0,20$

Type 7s: $0,25 \leq \kappa \leq 0,29$

Type 9s: $0,26 \leq \kappa \leq 0,29$

The shear stiffness results as follows:

$$G \cdot A_s = \kappa \cdot G \cdot A_{net} \quad (15)$$

Tabular calculation of the shear correction factor

The double integral $\int_h \frac{[E(z) \cdot S(z)]^2}{G(z) \cdot b} dz = \int_h \frac{[E(z) \cdot \int A \cdot z dz]^2}{G(z) \cdot b} dz$ can be determined layer by layer and added up. In that, first, the upper part of the cross-section from the cross-section's upper edge $z = z_{1,0}$ to the cross-section's centre of gravity is considered, and then the lower part of the cross-section from the cross-section's lower edge $z = z_{n,u}$ to the cross-section's centre of gravity $z = 0$.

(16)

For one layer considered, the analysis of the integral results in the following polynomial:

$$\int_{z_{i,o}}^{z_{i,u}} [E \cdot S]^2 dz = \frac{E_i^2 b^2}{60} (3 \cdot z_{i,u}^5 - 10 \cdot z_{i,o}^2 z_{i,u}^3 + 15 \cdot z_{i,o}^4 z_{i,u} - 8 \cdot z_{i,o}^5) + [E \cdot S]_i \frac{b \cdot E_i}{60} (20 \cdot z_{i,u}^3 - 60 \cdot z_{i,o}^2 z_{i,u} + 40 \cdot z_{i,o}^3) + [E \cdot S]_i^2 (z_{i,u} - z_{i,o}) \quad (17)$$

In that, the term $[E \cdot S]_i$ results by summing up all layers from the upper or lower, respectively, cross-section edge to the currently considered layer i:

$$[E \cdot S]_i = \sum_{k=1}^{i-1} [E \cdot S]_{z_{k,o}}^{z_{k,u}} \quad (18)$$

In that, the portion of an individual layer k is:

$$[E \cdot S]_{z_{k,o}}^{z_{k,u}} = E_k b \cdot \left(\frac{z_{k,u}^2}{2} - \frac{z_{k,o}^2}{2} \right) \quad (19)$$

Therewith, the shear correction coefficient can be calculated in a tabular manner by forming subtotals.

Approximate calculation of the shear correction factor

For symmetrical build-ups, continuously equal laminate thicknesses and the shear moduli ratio of $\frac{G_{90}}{G_0} = \frac{1}{10}$, Jöbstl indicated the following values:

1 layer	3 layers	5 layers	7 layers	9 layers
of equal layer thickness				
$\kappa = 0,83$	$\kappa = 0,21$	$\kappa = 0,24$	$\kappa = 0,26$	$\kappa = 0,27$

Calculation of deformation

Deformation is calculated from the following terms

$$w = \underbrace{\int \frac{M \cdot \bar{M}}{E \cdot I_{net}} dx}_{w_M} + \underbrace{\int \frac{V \cdot \bar{V}}{G \cdot A_s} dx}_{w_V} \quad (20)$$

At the example of a single-span girder with a uniformly distributed load, the following generally known equation is obtained for centre deflection:

$$w = \underbrace{\frac{5 \cdot q \cdot \ell^4}{384 \cdot E \cdot I_{net}}}_{w_M} + \underbrace{\frac{q \cdot \ell^2}{8 \cdot G \cdot A_s}}_{w_V} \quad (21)$$

For a girder with a point load in the centre results the following generally known equation:

$$w = \underbrace{\frac{F \cdot \ell^3}{48 \cdot E \cdot I_{net}}}_{w_M} + \underbrace{\frac{F \cdot \ell}{4 \cdot G \cdot A_s}}_{w_V} \quad (22)$$

A.2.5 Stress verifications

The stress verifications are undertaken with the assumption of rigidly connected parts of the cross-section, as explained in Chapter 4.

A.3 List of references

Author, Year	Quote
Altenbach et al. (1996)	Altenbach, Holm, Johannes Altenbach und Rikards Rolands (1996): <i>Einführung in die Mechanik der Laminat- und Sandwichtragwerke</i> , Stuttgart: Deutscher Verlag für Grundstoffindustrie.
Augustin (2012)	Augustin, Manfred (2012): <i>Personeninduzierte Schwingungen von Deckenkonstruktionen aus Holz</i> , Manuskript des Verfassers, erstellt für den Fachnormenausschuss FNA 012-02 des as-instituts, Graz.
BDZ (2011)	Holzbau Deutschland – Bund Deutscher Zimmermeister (Hrsg.) (2011): <i>Holzbauten in Deutschen Erdbebengebieten – Regelungen nach DIN 4149:2005-04</i> , September 2011.
Blaß und Uibel (2009)	Blaß, Hans Joachim, Thomas Uibel: „Bemessungsvorschläge für Verbindungsmittel in Brettspertholz“, in: <i>Bauen mit Holz</i> , Nr. 2, 2009, S.-46-53. Download unter: www.rz.uni-karlsruhe.de/~gc20/IHB/PUBLIC/61.pdf (26.9.2012)
Blaß und Uibel (2007)	Blaß, Hans Joachim, und Thomas Uibel (2007): <i>Tragfähigkeit von stiftförmigen Verbindungsmitteln in Brettspertholz</i> , Karlsruher Berichte zum Ingenieurholzbau [Band 8], Lehrstuhl für Ingenieurholzbau und Baukonstruktionen (Hrsg.), Karlsruhe: Universität Karlsruhe (TH).
Blaß, Ehlbeck, Kreuzinger und Steck (2005)	Blaß, Hans Joachim, Jürgen Ehlbeck und Heinrich Kreuzinger, Günther Steck (2005): <i>Erläuterungen zu DIN 1052:2004-08, Entwurf, Berechnung und Bemessung von Holzbauwerken</i> , Karlsruhe: Bruderverlag.
Bogensperger et al. (2011)	Bogensperger, Thomas, Manfred Augustin und Gerhard Schickhofer (2011): <i>Properties of X-Lam-Panels Exposed to Compression Perpendicular to their Plane</i> , CIB-W18, Meeting Forty-Four, Alghero, Italien.
Brunner et al. (2003)	Brunner, Roland, Pirmin Jung, René Steiger, Thomas Wenz und Niklaus Wirz (2003): <i>Erdbe-bengerechte mehrgeschossige Holzbauten</i> , Zürich: Lignum Verlag.
CEN (2012)	Report from the working group on Reinforcement of timber structures: Design of reinforcement to carry tensile stresses perpendicular to the grain, Document CEN/TC 250/SC 5: N 289.
DIN 1052	DIN 1052 Entwurf, Berechnung und Bemessung von Holzbauwerken - Allgemeine Bemessungsregeln und Bemessungsregeln für den Hochbau [2008-12, einschließlich Berichtigung 1:2010-05].
Ebner (2003)	Ebner, Hannes (Hrsg.) (2003): <i>Leitdetails für den Holzwohnbau</i> , Graz: Institut für Hochbau. Download unter: www.proholz-stmk.at/images/stories/Holzfachberatung/leitdetailkatalogformatpdf.pdf (7.12.12)
EN 1990	EN 1990/A1: Eurocode – Grundlagen der Tragwerksplanung, Ausgabe: 2006-09-01.
EN 16351:2013	prEN 16351: Timber structures – Cross laminated timber – Requirements, Entwurfsfassung: 2011-07.
EN 1995-1-1	Eurocode 5: Bemessung und Konstruktion von Holzbauten – Teil 1-1: Allgemeines – Allgemeine Regeln und Regeln für den Hochbau (konsolidierte Fassung), Ausgabe: 2009-07-01.
EN 1995-1-2	EN 1995-1-2: Bemessung und Konstruktion von Holzbauten – Teil 1-2: Allgemeine Regeln – Tragwerksbemessung für den Brandfall (konsolidierte Fassung), Ausgabe: 2011-09-01.
EN 1998-1	Eurocode 8: Auslegung von Bauwerken gegen Erdbeben – Teil 1: Grundlagen, Erdbebeneinwirkungen und Regeln für Hochbauten, Ausgabe 2011-06-15.
Giardini et al. (2012)	Giardini, Domenico, Maria José Jiménez und Gottfried Grünthal (Hrsg.) (2003): <i>The Esc-Sesame Unified Seismic Hazard Model for the European-Mediterranean Region</i> . URL: www.ija.csic.es/gt/earthquakes (25.11.12)
Green (2012)	Green, Michael (2012): <i>Tall Wood, The case for Tall Wood Buildings - How Mass Timber Offers a Safe, Economical, and Environmentally Friendly Alternative for Tall Building Structures</i> , Canadian Wood Council, Ottawa. Download: http://wecbc.smallboxcms.com/database/rte/files/Tall%20Wood.pdf (18.1.13)
Hamm und Richter (2009)	Hamm, Patricia, und Antje Richter (2009): <i>Bemessungs- und Konstruktionsregeln zum Schwingungsnachweis von Holzdecken</i> , in: Landesbeirat Holz Baden-Württemberg e. V. (Hrsg.), <i>Tagungsband der Fachtagungen Holzbau 2009</i> , Leinfelden-Echterdingen, 26. November 2009, S. 15–29.
HFA (2003)	Österreichische Gesellschaft für Holzforschung: <i>dataholz.com – Katalog bauphysikalisch und ökologisch geprüfter Holzbauteile</i> , Online-Ressource: 2003-2012. Abrufbar unter: www.dataholz.at/de/index.html (7.12.12)
Hivoss (2008)	European Commission (2008): <i>Human-induced vibration of steel structures (Hivoss) – Schwingungsbe-messung von Decken, Leitfäden</i> . Download unter: www.stb.rwth-aachen.de/projekte/2007/HIVOSS/download.php (27.8.12)
Jöbstl und Schickhofer (2007)	Jöbstl, Robert, und Gerhard Schickhofer: <i>Comparative examination of creep of GLT- and X-Lam-slabs in Bending</i> , in: Working Commission W18 - Timber Structures, 2007, S. 1-15.
Kreuzinger und Mohr (1999)	Kreuzinger, Heinrich, und Bernhard Mohr (1999): <i>Gebrauchstauglichkeit von Wohnungsdecken aus Holz – Abschlußbericht</i> . Stuttgart: Fraunhofer IRB Verlag, 1999.

Leonhardt (1973)	Leonhardt, Fritz, und Eduard Mönnig (1973): <i>Vorlesungen über Massivbau, Erster Teil: Grundlagen zur Bemessung im Stahlbetonbau</i> , Zweite Auflage, Heidelberg: Springer.
Leonhardt (1977)	Leonhardt, Fritz, und Eduard Mönnig (1977): <i>Vorlesungen über Massivbau, Dritter Teil: Grundlagen zum Bewehren im Stahlbetonbau</i> , Dritte Auflage, Heidelberg: Springer.
Lignum (2010)	Lignum Holzwirtschaft Schweiz (Hrsg.) (2010): <i>Erdbeengerechte mehrgeschossige Holzbauten, Technische Dokumentation der Lignum</i> , Zürich.
Mestek et al. (2011)	Mestek, Peter, Heinrich Kreuzinger und Stefan Winter (2011): <i>Design Concept for X-Lam Reinforced with Selftapping Screws</i> , CIB-W18, Meeting Forty-Four, Alghero, Italien.
Müller (1978)	Müller, Fritz Peter (1978): <i>Baudynamik, Betonkalender</i> , Teil II. Berlin: Ernst und Sohn.
ÖNORM B 1990-1	ÖNORM B 1990-1: Eurocode - Grundlagen der Tragwerksplanung - Teil 1: Hochbau - Nationale Festlegungen zu ÖNORM EN 1990, Anhang A1:2003.
Rabold und Hamm (2009)	Rabold, Andreas, und Patricia Hamm: <i>Schall- und schwingungsoptimierte Holzdecken</i> , in: <i>Bauen mit Holz</i> , Nr. 4, 2009, S. 38–43.
Report EUR 21972 EN (2006)	European Commission (2006): <i>Report EUR 21972 EN, Generalisation of criteria for floor vibrations for industrial, office, residential and public building and gymnastic halls.</i>
Ringhofer und Schickhofer (2011)	Ringhofer, Andreas, und Gerhard Schickhofer (2011): <i>Erdbebennormung in Europa und deren nationale Auslegungen</i> , in: <i>Tagungsband zur 9. Grazer Holzbau-Fachtagung</i> , Graz.
Sandhaas (2006)	Sandhaas, Carmen (2006): <i>Projekt SOFIE – Erdbebenverhalten von Häusern aus XLAM</i> , in: <i>Tagungsband zur 5. Grazer Holzbauaufachtagung</i> , Graz.
Schickhofer et al. (2010)	Schickhofer, Gerhard, Thomas Bogensperger und Thomas Moosbrugger (Hrsg.): <i>BSPHandbuch – Holz-Massivbauweise in Brettspertholz, Nachweise auf Basis des neuen europäischen Normenkonzepts</i> , 2. Auflage, Graz: Verlag der Technischen Universität Graz, 2010.
Schmid et al. (2010)	Schmid, Joachim, und Jürgen König (2010): <i>Cross-laminated Timber in Fire</i> , SP Report 2010:211, Stockholm.
Schneider (2012)	Schneider, Klaus-Jürgen (Hrsg.) (2012): <i>Bautabellen für Ingenieure mit Berechnungshinweisen und Beispielen</i> , 20. Auflage, Stuttgart: Werner Verlag.
Silly (2010)	Silly, Gregor (2010): <i>Numerische Studien zur Drill- und Schubsteifigkeit von Brettspertholz (X-Lam)</i> , Diplomarbeit am Institut für Holzbau und Holztechnologie, Technische Universität Graz.
Stahlbauzentrum Schweiz (2005)	Stahlbauzentrum Schweiz (Hrsg.) (2005): <i>Konstruktionstabellen Steelwork C5/05</i> , Zürich: Verlag Stahlbau Zentrum Schweiz.
Steinmetz (1988)	Steinmetz, Dieter: <i>Die Aussteifung von Holzhäusern am Beispiel des Holzrahmenbaues</i> , in: <i>Bauen mit Holz</i> , Nr. 12, 1988, S. 842-851.
Teibinger et al. (2012)	Teibinger, Martin, und Florian Ehrlich 2012: <i>Bemessungsregeln für Brettspertholzbauteile im Brandfall</i> , Fachbeitrag als Manuskript der Verfasser, Wien: Holzforschung Austria.
Teibinger und Matzinger (2010)	Teibinger, Martin, und Irmgard Matzinger (2010): <i>Grundlagen zur Bewertung des Feuerwiderstandes von Holzkonstruktionen</i> , Wien: Holzforschung Austria.
Teibinger und Matzinger (2013)	Teibinger, Martin, und Irmgard Matzinger (2013): <i>Bauen mit Brettspertholz in GK 3 und GK4</i> , Planungsbroschüre, Wien: Holzforschung Austria.
VDI 2700:2002	VDI 2700 Blatt 2:2002-11: Ladungssicherung auf Straßenfahrzeugen - Zurrkräfte.
Walter und Fritzen (2008)	Walter, Burkhard, und Klaus Fritzen: <i>Erdbebenbeanspruchung bei Holztragwerken</i> , in: <i>Bauen mit Holz</i> , Nr. 12, 2008, S.42-49; Nr. 2, 2009, S. 32–39.
Walther und Wiesenkämpfer (2011)	Walther, Burkhard, und Tobias Wiesenkämpfer (2011): <i>Nachweis der Erdbebensicherheit von Holzgebäuden</i> , Aachen: Studiengemeinschaft Holzleimbau e. V. Download unter: www.brettschichtholz.de/publish/binarydata/aktuelles/nachweis_erdbebensicherheit_holzgebaeude.pdf (7.12.12)
Winter et al. (2009)	Winter, Stefan, Heinrich Kreuzinger, und Peter Mestek (2009): <i>Holzbau der Zukunft, Teilprojekt 15. Flächen aus Brettstapeln, Brettspertholz und Verbundkonstruktionen</i> , Reihe Holzbauforschung [Band 7/15], Stuttgart: Fraunhofer IRB Verlag.

Cross-sectional values for cross-laminated timber with fictitious build-ups – Ceilings and roofs

Designation	Build-up	$I_{0,net}$ [cm ⁴]	$W_{0,net}$ [cm ³]	$S_{R,net}$ [cm ³]	$A_{R,\tau}$ [cm ²]	$I_{0,ef}/l_{ref}$						χ [-]
						2,00 m	3,00 m	4,00 m	5,00 m	6,00 m	7,00 m	
XLAM 130 C5s	30l-20w-30l- 20w-30l	15.675 86 %	2.412	1.500	1.567	11.990 65 %	13.778 75 %	14.546 79 %	14.932 82 %	15.151 83 %	15.287 83 %	0,193
XLAM 150 L5s	30l-30w-30l- 30w-30l	22.275 79 %	2.970	1.800	1.856	15.186 54 %	18.422 65 %	19.924 71 %	20.709 74 %	21.163 75 %	21.447 76 %	0,184
XLAM 160 L5s	40l-20w-40l- 20w-40l	30.400 89 %	3.800	2.400	1.900	21.680 64 %	25.741 75 %	27.580 81 %	28.529 84 %	29.074 85 %	29.414 86 %	0,208
XLAM 220 L7s	40l-20w-40l- 20w-40l-20w-40l	74.196 84 %	6.739	4.800	2.319	43.594 49 %	56.360 64 %	62.921 71 %	66.530 75 %	68.676 77 %	70.042 79 %	0,217
XLAM 220 L7s2	30l-30l-30w-40l- 30w-30l-30l	80.933 91 %	7.358	4.800	2.529	42.978 48 %	57.680 65 %	65.856 74 %	70.550 80 %	73.412 83 %	75.260 85 %	0,188

Cross-sectional values for cross-laminated timber with fictitious build-ups – Walls

Designation	Build-up	$A_{0,net}$ [cm ²]	$I_{0,net}$ $\frac{I_{net}}{I_{brut}}$ [cm ⁴]	$W_{0,net}$ [cm ³]	$S_{R,net}$ [cm ³]	$A_{R,\tau}$ [cm ²]	$I_{0,ef}[cm^4]/I_{0,ef}[cm^4]/\lambda[-]$ l_{ref}						χ [-]
							2,50 m	2,95 m	3,00 m	4,00 m	5,00 m	6,00 m	
XLAM 90 C3s	30l-30w-30l	600	5.850 96 %	1.300	900	975	5.120 2,92 86	5.305 2,97 99	5.321 2,98 101	5.539 3,04 132	5.647 3,07 163	5.707 3,08 195	0,155
XLAM 120 C3s	40l-40w-40l	800	13.867 96 %	2.311	1.600	1.300	11.083 3,72 67	11.737 3,83 77	11.796 3,84 78	12.613 3,97 101	13.035 4,04 124	13.277 4,07 147	0,155
XLAM 100 C3s	30l-40w-30l	600	7.800 94 %	1.560	1.050	1.114	6.532 3,30 76	6.843 3,38 87	6.871 3,38 89	7.247 3,48 115	7.436 3,52 142	7.543 3,55 169	0,152
XLAM 130 C5s	30l-20w-30l- 20w-30l	900	15.675 86 %	2.412	1.500	1.567	13.088 3,81 66	13.722 3,90 76	13.778 3,91 77	14.546 4,02 99	14.932 4,07 123	15.151 4,10 146	0,193
XLAM 150 C5s	30l-30w-30l- 30w-30l	900	22.275 79 %	2.970	1.800	1.856	17.130 4,36 57	18.314 4,51 65	18.422 4,52 66	19.924 4,71 85	20.709 4,80 104	21.163 4,85 124	0,184

Fictitious element build-ups used in the guideline with cross-sectional values for dimensioning of elements subjected to bending according to Chapters 5 and 6 of the present guideline.

The element build-ups above are fictitious and were defined independently of respective manufacturers. The tables represent a possible listing of the cross-sectional values for dimensioning according to the present guideline. For manufacturer-related build-ups and corresponding cross-sectional-values, please contact one of the manufacturers.

$A_{0,net}$ Net area – in the direction of the top layers in cm²
 $I_{0,net}$ Net moment of inertia – in the direction of the top layers in cm⁴
 $W_{0,net}$ Net section modulus – in the direction of the top layers in cm³
 $S_{R,net}$ Net static moment – in the direction of the top layers in cm³
 $A_{R,\tau}$ Equivalent area for determination of the decisive rolling shear stress in cm²
 $I_{0,ef}$ Effective moment of inertia – in the direction of the top layers in cm⁴
 $i_{0,ef}$ Effective radius of inertia – in the direction of the top layers in cm
 l_{ref} Reference length or buckling length in m
 λ Slenderness (no unit)
 χ Shear correction factor for calculation as a transversally shear-flexible element (no unit)